

INSTRUCTION MANUAL

Model:5602

20MHz Dual Trace

Oscilloscope



HUNG CHANG

TABLE OF CONTENTS

SECTION 1 GENERAL INFORMATION

1-1	FEATURES	Page 4
1-2	SAFETY CONSIDERATIONS	4
1-3	INSTALLATION	5
1-4	STORAGE AND SHIPMENT	7
1-5	SPECIFICATIONS	7

SECTION 2 CIRCUIT DESCRIPTION

2-1	OVERALL BLOCK DIAGRAM	9
2-2	VERTICAL DEFLECTION UNIT	10
2-2-1	Attenuator Circuit	10
2-2-2	Preamplifier Circuit	10
2-2-3	Trigger Amplifier Circuit	10
2-2-4	Vertical Switching Circuit	10
2-2-5	Vertical Output Amplifier Circuit	10
2-3	HORIZONTAL DEFLECTION UNIT	11
2-3-1	Trigger Generator Circuit	11
2-3-2	Sweep Generator Circuit	11
2-3-3	Horizontal Switching Circuit	11
2-3-4	Horizontal Output Amplifier Circuit	11
2-4	POWER SUPPLY UNIT	11

SECTION 3 OPERATION

3-1	INITIAL SETUP	12
3-1-1	Operators Check	12
3-1-2	Trace Rotation Adjustment	12
3-1-3	Probe Adjustment	12
3-1-4	Cursor Measurement Method By Using The Cursor	13
3-2-1	Front Panel	13
3-2-2	Rear Panel	15
3-3	TRIGGERING	15
3-4	X-Y OPERATION	16
3-5	CALIBRATED VOLTAGE MEASUREMENTS	16
3-6	DUAL TRACE WAVEFORM OBSERVATION	16
3-7	TV SIGNAL SYNCHRONIZATION	16
3-8	ADD & SUB MEASUREMENTS	16
3-9	APPLICATIONS	16
3-9-1	AC Voltage and Frequency Measurement	17
3-9-2	DC Voltage Measurement	17
3-9-3	AM Modulation Measurement	18
3-9-4	Dual-Trace Applications	18
3-9-5	Level Comparison	18
3-9-6	Repairing Stereo Systems	19
3-9-7	TV Servicing	19
3-9-8	Composite Video Analysis	19
3-9-9	Measurement of Frequency by X-Y	19
3-9-10	Phase Measurement	19
3-9-11	Read Out Display	20

SECTION 4 ADJUSTMENT AND CALIBRATION

4-1	MAINTENANCE	21
4-2	TEST EQUIPMENTS REQUIRED	21
4-3	BASIC ADJUSTMENTS	22
4-3-1	Power Source	22
4-3-2	High Voltage Check	22
4-4	CRT ADJUSTMENTS	22
4-4-1	Intensity	22
4-4-2	Focus	22
4-4-3	Spot	22
4-5	VERTICAL ADJUSTMENTS	23
4-5-1	Step Balance Adjustment	23
4-5-2	Mag (X5) Balance Adjustment	23
4-5-3	Variable Balance Adjustment	23
4-5-4	Gain Adjustment	23
4-5-5	Mag (X5) Gain Adjustments	23
4-5-6	ADD Balance Adjustments	23
4-5-7	Band Balance Adjustments	23
4-5-8	1KHz Square Wave Adjustments	24
4-5-9	Input Capacity Adjustments	24
4-5-10	Trig DC Balance Adjustments	24
4-5-11	CH1 DC Balance Adjustment	24
4-5-12	X Gain Adjustment	24
4-6	HORIZONTAL TIME ADJUSTMENTS	25
4-6-1	X Cent Adjustment	25
4-6-2	Time 1mS/1 μ S Adjustment	25
4-6-3	Mag Cent Adjustment	25
4-7	Fundamental Adjust of READ Out Unit	26

SECTION 1. GENERAL INFORMATION

OUTLINE

The oscilloscope is comparatively light and small oscilloscope which have additional READ OUT function operated with ease. The extent of these oscilloscope's application reaches from research center to manufacturing area. Information displayed on the CRT includes: Vertical axis input sensitivity and sweep time with READ OUT function, time difference and voltage difference between two cursors due to Cursor function.

Following are the features of READ OUT oscilloscope.

1-1. FEATURES

- 1) DUAL TRACE 20MHz OSCILLOSCOPE WITH HIGH BRIGHTNESS CRT
- 2) CHANNEL 1 SIGNAL OUTPUT for USE WITH A FREQUENCY COUNTER
- 3) CH2 POLARITY INVERSION SWITCH
- 4) VERTICAL DEFLECTION MAGNIFICATION, X5
- 5) SWITCHABLE CHOPPING FREQUENCY
- 6) SCALE ILLUMINATING SYSTEM
- 7) VARIABLE HOLD-OFF for OBSERVATION of WAVEFORMS with COMPLEX PERIODS
- 8) SINGLE SWEEP MODE for ONE TIME OR OTHER SUDDENLY OCCURRING EVENTS
- 9) SWEEP MAGNIFICATION, X10
- 10) SIGNAL DELAY LINE FOR ACCURATE VIEW of HIGH FREQUENCY PULSE LEADING EDGE
- 11) TRIGGER PRESET FUNCTION
- 12) READ OUT FUNCTION

1-2. SAFETY CONSIDERATIONS

This instrument and related documentation must be reviewed for familiarization with safety markings and instructions before operation. Before applying power, verify that the product is set to match the available line voltage and the correct fuse is installed.

The safety information in this part is for both operating and servicing personnel. Specific warnings and cautions will be found throughout the manual where they apply and do not appear in this summary.

Power Source

This product is intended to operate from a power source that does not apply more than 250 volts rms between the supply conductors or between either supply conductor and ground. A protective ground connection by way of the grounding conductor in the power cord is essential for safe operation.

Grounding the Product

This product is grounded through the grounding conductor of the power cord. To avoid electrical shock, plug the power cord into a properly wired receptacle before connecting to the product input or output terminals. A protective ground connection by way of the grounding conductor in the power cord is essential for safe operation.

Danger Arising From Loss of Ground

Upon loss of the protective-ground connection, all accessible conductive parts (including knobs and controls that may appear to be insulating) can render an electric shock.

Use the Proper Power Cord

Use only the power cord and connector specified for your product. Use only a power cord that is in good condition. An uninterruptible safety earth ground must be provided from the main power source to the instrument input wiring terminals, power cord, or supplied power cord set.

Use the Proper Fuse

To avoid fire hazard, use only a fuse of the correct type, voltage rating and current rating as specified in the parts list for your product.

Do Not Operate in Explosive Atmospheres

To avoid explosion, do not operate this product in an explosive atmosphere unless it has been specifically certified for such operation.

Do Not Remove Covers or Panels

To avoid personal injury, do not remove the product covers or panels. Do not operate the product without the covers and panels properly installed.

WARNING

The WARNING signal denotes a hazard. It calls attention to a procedure, practice, or the like, which, if not correctly performed or adhered to, could result in personal injury. Do not proceed beyond a WARNING sign until the indicated conditions are fully understood and met.

CAUTION

The CAUTION sign denotes a hazard. It calls attention to an operating procedure, practice, or the like, which, if not correctly performed or adhered to, could result in damage to or destruction of part or all of the product. Do not proceed beyond a CAUTION sign until the indicated conditions are fully understood and met.

1-3. INSTALLATION

OPERATING ENVIRONMENT

- a. TEMPERATURE. This instrument may be operated in temperatures from 0°C to 50°C.
- b. HUMIDITY. This instrument may be operated in environments with humidity up to 90% RH at 35°C. However, it should be protected from temperature extremes which cause condensation in the instrument.
- c. ALTITUDE. This instrument may be operated at altitudes up to 4,600 metres (15,000 feet).

POWER REQUIREMENTS

This instrument requires a power source of 100V/117V/220V/240V $\pm 5\%$, single phase, 50 to 60Hz

LINE VOLTAGE SELECTION

WARNING

BEFORE SWITCHING ON THIS INSTRUMENT, THE PROTECTIVE EARTH TERMINAL OF THIS INSTRUMENT MUST BE CONNECTED TO THE PROTECTIVE CONDUCTOR OF THE (MAINS) POWER CORD. THE MAINS PLUG SHALL BE INSERTED ONLY IN A SOCKET OUTLET PROVIDED WITH A PROTECTIVE EARTH CONTACT. THE PROTECTIVE ACTION MUST NOT BE NEGATED BY THE USE OF AN EXTENSION CORD (POWER CABLE) WITHOUT A PROTECTIVE GROUNDING CONDUCTOR.

CAUTION

This instrument may be damaged if operated with the LINE VOLTAGE SELECTOR switch set for the wrong applied ac input-source voltage or if the wrong line fuse is installed.

Before connecting the power cord to a power-input source, verify that the LINE VOLTAGE SELECTOR switch, located on the rear panel, is set for the correct nominal ac input-source voltage. To convert the instrument for operation from one line-voltage range to the other, move the LINE VOLTAGE SELECTOR switch to the correct nominal ac source-voltage setting. The detachable power cord may have to be changed to match the particular power-source output.

LINE FUSE

To verify that the instrument power-input fuse is of proper value for the nominal ac source voltage selected, perform the following procedure:

1. Press in the fuse-holder cap and release it with a slight counterclockwise rotation.
2. Pull the cap (with the attached fuse inside) out of the fuse holder.
3. Verify proper fuse value
4. Install the proper fuse and reinstate the fuse-holder cap.

NOTE The two types of fuses listed are not directly interchangeable; they require different types of fuse caps.

POWER CORD

This instrument has a detachable, three-wire power cord with a three-contact plug for connection to both the power source and protective ground. The power cord is secured to the rear panel by a cord-securing clamp. The protective-ground contact on the plug connects (through the power-cord protective grounding conductor) to the accessible metal parts of the instrument. For electrical-shock protection, insert this plug into a power-source outlet that has a properly grounded protective-ground contact.

INSTRUMENT COOLING

To prevent instrument damage from overheated components, adequate internal airflow must be maintained at all times. Before turning on the power, first verify that both the air-intake holes on the bottom of the cabinet and the fan-exhaust holes in the rear panel are free of any obstruction to airflow.

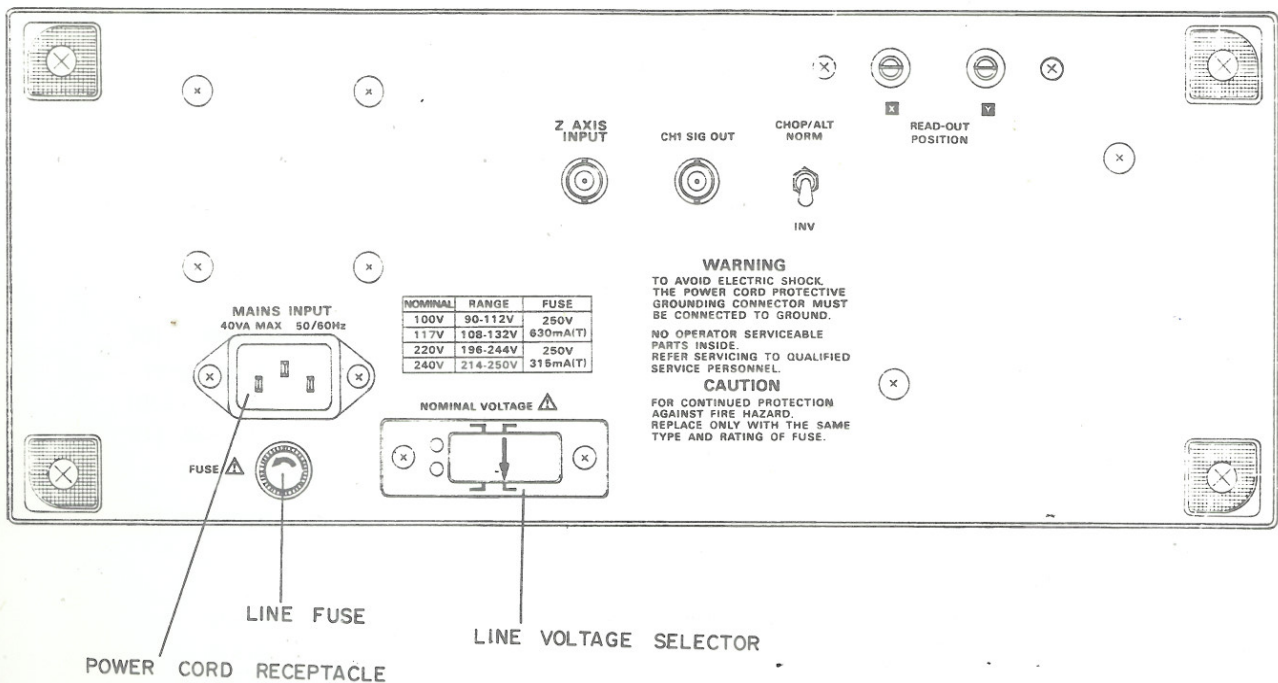

Fig. 1 LINE VOLTAGE SELECTOR

1-4. STORAGE AND SHIPMENT

ENVIRONMENT

The instrument may be stored or shipped in environments within the following limits:

TEMPERATURE	-40°C to +75°C
HUMIDITY	up to 90% RH at 60°C
ALTITUDE	7,620 metres (25,000 feet)

The instrument should also be protected from temperature extremes which cause condensation within the instrument.

PACKAGING

ORIGINAL PACKAGING

Containers and materials identical to those used in factory packaging should be maintained. If the instrument is being returned for servicing, attach a tag indicating the type of service required, return address, model number, and full serial number. Also, mark the container FRAGILE to ensure careful handling. In any correspondence, refer to the instrument by model number and full serial number.

OTHER PACKAGING

The following general instructions should be used for repacking with commercially available materials:

- Wrap instrument in heavy paper or plastic.
- Use a strong shipping container. A double-wall carton made of 350-pound test material is adequate.
- Use a layer of shock-absorbing material 70 to 100mm (3-to 4-inch) thick around all sides of the instrument to provide firm cushioning and prevent movement inside the container. Protect control panel with cardboard.
- Seal shipping container securely.
- Mark shipping container FRAGILE to ensure careful handling.
- In any correspondence, refer to instrument by model number and full serial number.

1-5. SPECIFICATIONS

1) VERTICAL DEFLECTION SYSTEM CHANNEL 1 AND CHANNEL 2

Sensitivity	: 5mV/DIV to 5V/DIV 1mV/DIV to 1V/DIV, X5 Mag
Accuracy	: $\pm 3\%$
Attenuator	: 10 steps, 5mV/DIV to 5V/DIV in 1-2-5 sequence
Bandwidth	: DC: DC to 20MHz, -3dB (X5 Mag: DC to 10MHz, -3dB) AC: 5Hz to 20MHz, -3dB (X5 Mag: 5Hz to 10MHz, -3dB)
Rise Time	: Less than 17.5 nS
Maximum Input Voltage	: 400V (DC + AC peak)
Input Impedance	: 1M ohm $\pm 2\%$, Apprx 25pF
Polarity Inversion	: CH2 only
Chop Frequency	: Approx 250KHz
Operating Mode	: CH1, CH2, ADD, DUAL
Overshoot	: Less than $\pm 6\%$ (5mV/div to 0.5V/div, X1)

2) HORIZONTAL DEFLECTION SYSTEM

Operating Modes	: X-Y operation CH1-X axis, CH2-Y axis
Input Impedance	: 1M ohm, 25pF
Bandwidth	: DC: DC to 1MHz (-3dB) AC: 5Hz to 1MHz (-3dB)
X-Y Phase Shift	: 3° or less (at 50KHz)
Maximum Input Voltage	: 400V (DC+AC peak)

3) TIME BASE

Sweep Modes	: AUTO, NORM, SINGLE
Sweep Time	: 0.2 μ S-0.5S/DIV \pm 3% in 1-2-5 steps (X1 only)
Magnified Sweep	: 10 times \pm 5%, Max. 20nS
Hold Off	: Continuously adjustable

4) TRIGGERING

Trigger Source	: CH1, CH2, LINE, EXT
Coupling	: AC, HF REJ, TV, DC
Trigger Sensitivity	: INT: DC~10MHz 1.0 div ~20MHz 2.0 div EXT: DC~10MHz 150mVp-p ~20MHz 300mVp-p
Trigger Level Preset	: INT : 50Hz~10MHz 1.5 div ~20MHz 3.0 div EXT: 50Hz~10MHz 150mVp-p ~20MHz 300mVp-p

5) VERTICAL AMPLIFIER SIGNAL OUTPUT

Output Voltage	: Approx, 50mV/DIV
Output Impedance	: 50 ohm
Bandwidth	: 50Hz-20MHz (-3dB)

6) INTENSITY MODULATION Z AXIS

Bandwidth	: DC -1MHz
Maximum Input Voltage	: 50V (DC+AC peak), MAX AC 1KHz
Sensitivity	: 3Vp-p

7) PROBE CALIBRATOR OUTPUT VOLTAGE

Squarewave Approx 1KHz (\pm 20%), 1Vp-p (\pm 2%)

8) CRT DISPLAY

150mm rectangular, type with an illuminated, parallax-free, inner-face graticule
2KV accelerating potential
8 \times 10 divisions (1 division=10mm)

9) POWER REQUIREMENTS

Voltage	: AC 100V/117V/220V/240V \pm 10%, 50/60Hz
Power	: 42W

10) DIMENSIONS, NET WEIGHT

356 \times 147 \times 435mm, 9kg

11) ACCESSORIES

X1, Ref, X10 probe 2 pcs (optional), operational manual, power lead, fuse

12) READOUT FUNCTION

Switching frequency 500KHz

1) Panel display contents	
Vertical Axis (CH 1, CH 2)	: V/Div, MAG, UNCAL (Calculated Value)
Horizontal Axis	: Sec/Div, MAG, UNCAL (Calculated Value)
2) Cursor Reading Measurement	
Voltage difference ΔV	: Δ - REF
Time difference Δt	: Δ - REF
Effective Measurement Range	: Vertical : \pm 3Div Horizontal : \pm 4Div
Cursor Memory	: 2 Memory
Frequency $\Delta f/t$: Δ - REF
Ratio $\Delta t\%$: Δ - REF (100.0% at 10Div)
Phase Δt°	: Δ - REF (360.0 at 10Div)

SECTION 2. CIRCUIT DESCRIPTION

2-1. OVERALL BLOCK DIAGRAM

This oscilloscope is equipped with 2 identical input attenuators and preamplifiers. The input signal is attenuated to the required level, amplified to the preamplifier, and led to the trigger pick off circuit, then to the switching circuit.

At the trigger pick off circuit, a part of the signal is picked up and fed to the trigger select logic for either CH1, CH2 and led to the trigger amplifier of the TIME BASE Block.

The switching circuit consists of diode-gate and mode control logic to select CH-1, CH-2, ADD and DUAL.

After the switching circuit the signal is amplified, and goes through a cascade type final stage amplifier for CRT vertical deflector.

The trigger signal or an external trigger signal is amplified and reformed as a clock pulse to drive the following saw tooth generator circuit, which consists of JKRS flip-flops and sweep controller, FET input Miller integrator, hold-off.

The saw tooth wave generated by the clock pulse, is led to a differential amplifier which is equipped with a stabilized current supply, then fed to CRT horizontal deflector. For X-Y operation, CH-1 input signal is led to the pick-off circuit, sweep X-Y selector, then horizontal final amplifier.

The Q signal in the sweep control flip-flop and NAND of chopper rising edges are used for unblanking and chop-blanking. It is led to a cascade amplifier with a constant current load, a DC producing circuit and then added on to a high voltage, and then fed between the control grid and cathode of the CRT. The CRT is cut off during trace fly-back, and while waiting for trigger and during chop change-over time.

The power supplies are all regulated. A feed back type DC-DC converter is used for generating the stabilized high voltage to CRT.

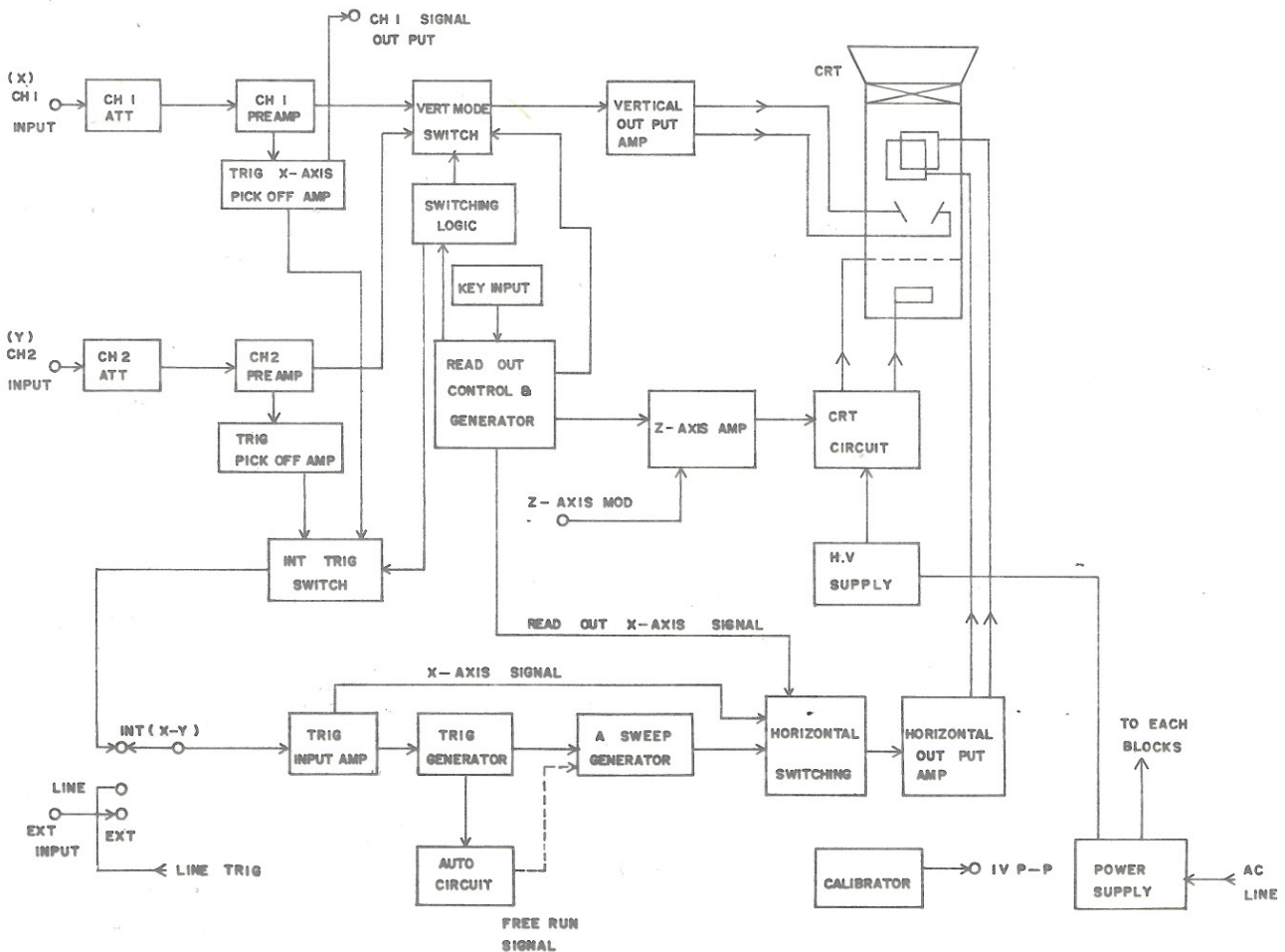

Fig. 2 OVERALL BLOCK DIAGRAM

2-2. VERTICAL DEFLECTION UNIT

Vertical deflection unit is composed of CH1 and CH2 attenuator, preamplifier, trigger amplifier, vertical switching and vertical output amplifier. Its block diagram is as follows:

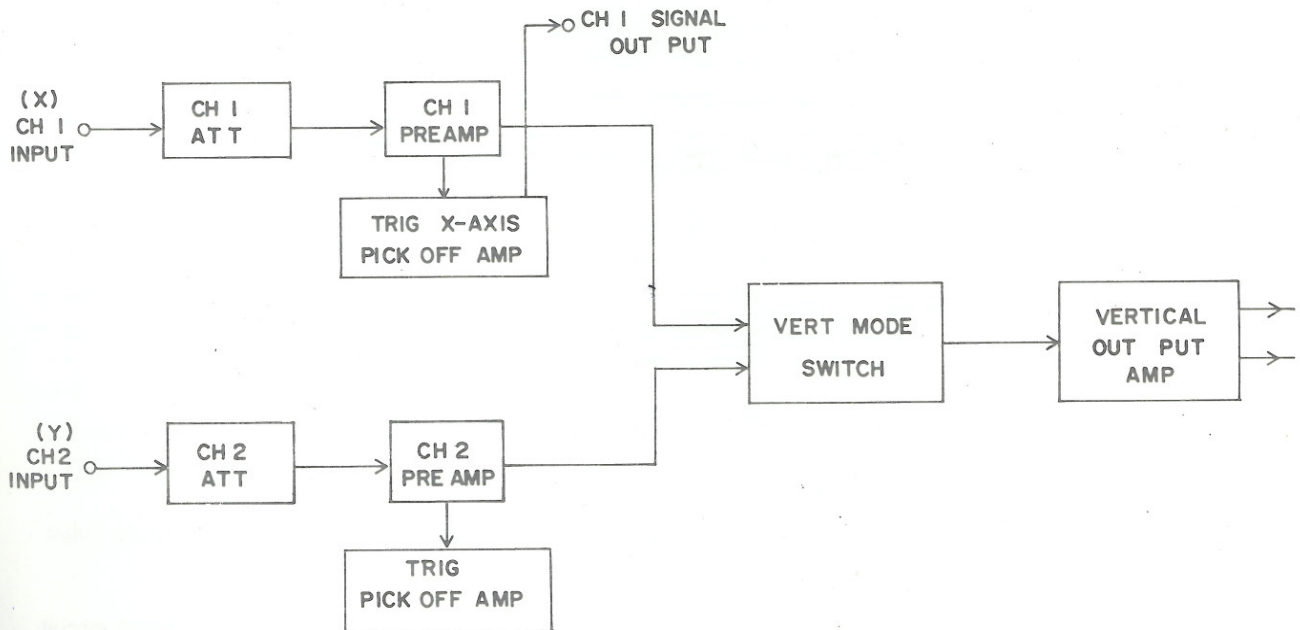

Fig. 3 VERTICAL DEFLECTION UNIT

2-2-1. ATTENUATOR CIRCUIT

CH1 and CH2 attenuators are identical in operation, with corresponding circuitry in each channel performing the same function. Input signals from BNC input terminals are attenuated through attenuator network circuit (for example)

The attenuator circuit has two sections, the first attenuates by ratios of 1:1, 10:1, 100:1 and the second by ratios of 2:1, 5:1, 10:1.

2-2-2. PREAMPLIFIER CIRCUIT

Preamplifier circuit converts the single-ended input signal from the attenuator to a differential output signal. It includes compensating circuits to get a good input signal waveform and to adjust square wave response.

2-2-3. TRIGGER AMPLIFIER CIRCUIT

Input signals amplified in preamplifier circuit are fed to the trigger amplifier circuit, as well as to the switching circuit. Trigger amplifier circuit amplifies the input signals fed from preamplifier and distributing to horizontal deflection unit and vertical switching circuit.

2-2-4. VERTICAL SWITCHING CIRCUIT

Vertical switching circuit is composed of diode-gate and mode control logic circuit to select CH-1, CH-2, DUAL and ADD. Mode control logic circuit is controlled by the output of diode-gate and conveying the selected signal to vertical output amplifier circuit.

2-2-5. VERTICAL OUTPUT AMPLIFIER CIRCUIT

The vertical signal through diode switching circuit passes the limiter circuit to obtain an adequate level, and then is fed to the output amplifier. The output obtained is sufficiently amplified by the amplifier with a constant current load. This amplifier is equipped with a booster for high frequency contents to obtain flat signal response. The signal is then fed to the vertical deflection plates of CRT.

2-3. HORIZONTAL DEFLECTION UNIT

Horizontal deflection unit is composed of trigger generator, sweep generator, horizontal switching and horizontal output amplifier. Its block diagram is as follows:

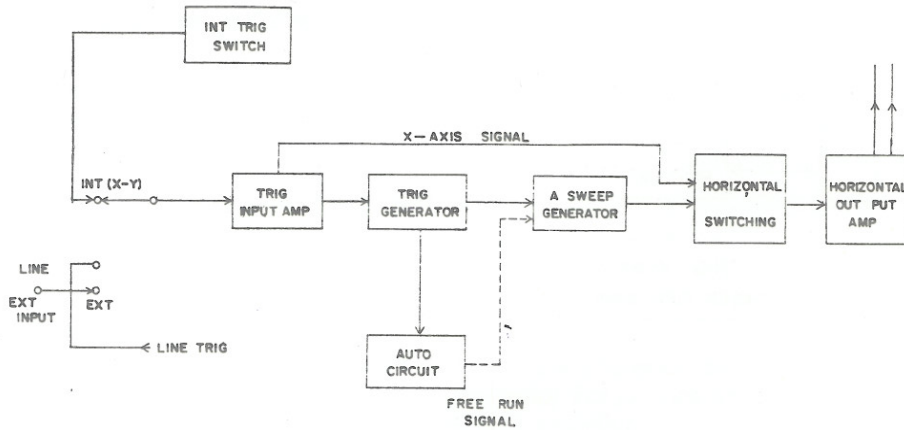

Fig. 4 HORIZONTAL DEFLECTION UNIT

2-3-1. TRIGGER GENERATOR CIRCUIT

Internal or external trigger signal is amplified and then activates the sweep generator circuit by clock pulse.

2-3-2. SWEEP GENERATOR CIRCUIT

The sweep generator circuit consists of sweep control circuit, MILLER integrator circuit, sweep length circuit and HOLD OFF circuit (see figure) and it is initiated by clock pulse.

2-3-3. HORIZONTAL SWITCHING CIRCUIT

Horizontal switching circuit is divided by trigger selector and time selection switch

Trigger selector switch selects the source and coupling according to characteristic of input signals from trigger generator

Time selection switch controls input signals from sweep generator and convey to horizontal output amplifier circuit

2-3-4. HORIZONTAL OUTPUT AMPLIFIER CIRCUIT

The horizontal output circuit amplifies signals from sweep generator circuit through differential amplifier circuit and conveys then to the CRT X-plate.

2-4. POWER SUPPLY UNIT

The power supply circuit is mainly designed using operational amplifiers and controlled by regulator circuits to supply stable power. High voltage for CRT is supplied by feed-back DC-AC converter generating the stable high voltage.

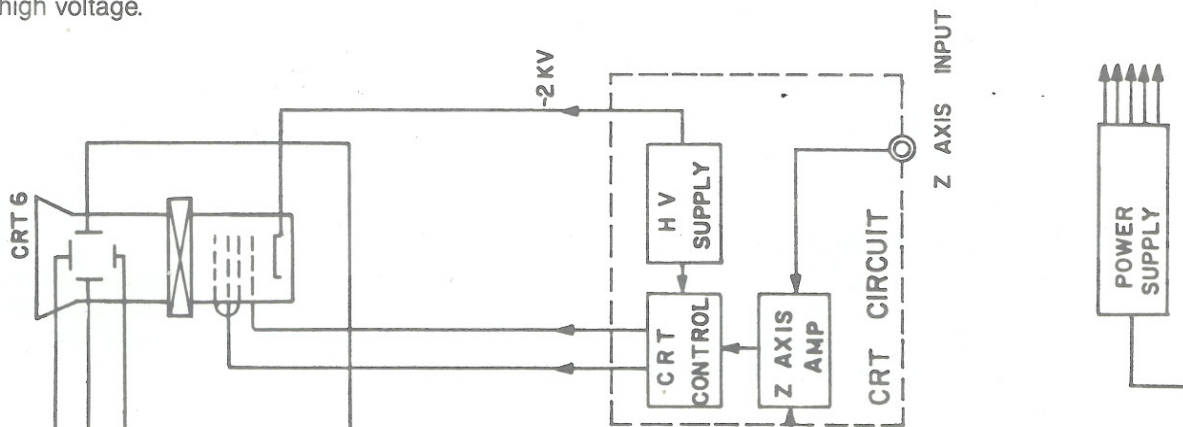

Fig. 5 POWER SUPPLY UNIT

SECTION 3. OPERATION

3-1. FIRST-TIME OPERATION

3-1-1. OPERATORS CHECK

- 1) Prior to any kind of operation of the instrument, proceed as follows to get familiarized with the instrument.
 - a) Set the power switch ① to OFF.
 - b) Turn all the three POSITION controls ⑦, ⑫, ⑳ to mid-position.
 - c) Turn INTENSITY control ③ to mid-position ㉓ Turn TRIG LEVEL control ㉔ to FIX
 - e) Push SWEEP MODE switch ⑲ for AUTO
 - f) Check the AC line voltage ㉕
- 2) Connect the AC line cable into the AC receptacle on the rear panel of the instrument and plug into an AC power outlet.
- 3) Turn Power ① to ON. After approximately 10 seconds, trace lines appear on CRT creen. If no trace line appèar, rotate INTENSITY, clockwise till trace lines are easily observed.
- 4) Adjust FOCUS and INTENSITY Controls for clear tràce lines.
- 5) Readjust Vertical and Horizontal POSITION controls for location required.

3-1-2. TRACE ROTATION ADJUSTMENT

- 1) Preset instrument controls and obtain a baseline trace as described in operators check
- 2) Use the channel 1 position control to move the base line trace to the center horizontal graticule line
- 3) If the trace is not parallel to the graticule line, use a small-bladed screwdriver to adjust the TRACE ROTATION control and align the trace with the graticule line

3-1-3. PROBE ADJUSTMENT

- 1) Misadjustment of probe compensation is one of the sources of measurement error. The attenuator probes are equipped with compensation adjustment. To ensure optimum measurement accuracy, always check probe compensation before making measurements.
- 2) Preset instrument controls and obtain a base trace as described in operators check.
- 3) Connect a probe (10:1) to INPUT of CH1 and hook the tip of the probe to probe adjust 1V output. Set AC-GND-DC switch to DC
- 4) Rotate CH1 Vertical attenuator VOLT/DIV switch to 0.2/DIV and turn the variable on the same axis clockwise to detent (CAL). Turn TRIG SOURCE to CH1. Then a square wave of 5 DIV is displayed on the screen.
- 5) If the square wave is distorted as Fig. 6, adjust the trimmer of the probe till it becomes a good square wave as Fig. 7.

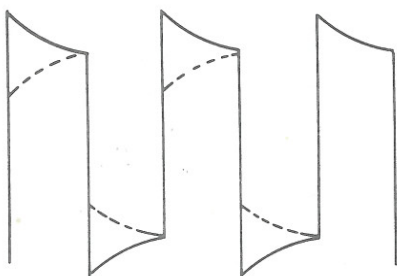

Fig. 6 DISTORED

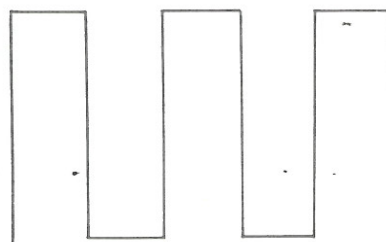

Fig. 7 GOOD

- 6) Remove the probe tip from probe adjust 1V output. Now the Oscilloscope is ready for use.

3-1-4. CURSOR MEASUREMENT METHOD BY USING THE CURSOR

By using the two Cursors, measured value of ΔV and Δt is simultaneously displayed on CRT

*NOTE: When the power is on again, the cursor display will be set as the initial state

a) Cursor Selection

By applying the select switch, select the REF Cursor.(X) or Δ Cursor(Δ) to be used The selected Cursor is brighten. In case that both of them are brighten, the tracking can be done.

b) Cursor Movement

Set the selected Cursor to the position of waveform to be measured by applying Cursor movement switches. It is possible to move the Cursor diagonally with a combination of them. Push all cursor movement s/w simultaneously, and READOUT function is turned off.

c) Measured Value Display

Both Δt and ΔV are displayed on the upper in CRT.

d) Application of Cursor Memory

According to the Cursor Memory s/w. Both CP 1 and CP 2 are displed on CRT as the two Cursor positions. In case of Cursor Memory 1, set the two Cursors on each end position of wave and push the Cursor Memory s/w again.

In case of Cursor Memory 2, set the two Cursors on each end position of wave and the above two Cursors' positions are memorized, also possible to compare. ΔV and Δt by pushing Cursor memory s/w as the waveform.

e) Photography of CRT Panel

Adjusting scale illumination volume, possible to record waveform and valued data Cursor with ease and rapidity.

*NOTE: With power on, value shows initial value. Pushing cursor select s/w and cursor move s/w simultaneously, the value of ΔV and Δt will be set on the value of 6 Div, 8Div.

f) Value of $\Delta 1/t$, Ratio, Phase.

With pushing cursor select s/w and cursor memory s/w simultaneously, Δt can be switched to $\Delta 1/t$ Mode, and push again $\Delta 1/t$ reverses to Δt Mode.

Using $\Delta 1/t$ Mode, possible to measure the frequency simply, in case of Δt Mode, according to setting time variable to UNCAL, it becomes PHASE MODE and possible to Measure the phase difference of waveform.

3-2. CONTROLS, CONNECTORS AND INDICATORS

3-2-1. FRONT PANEL

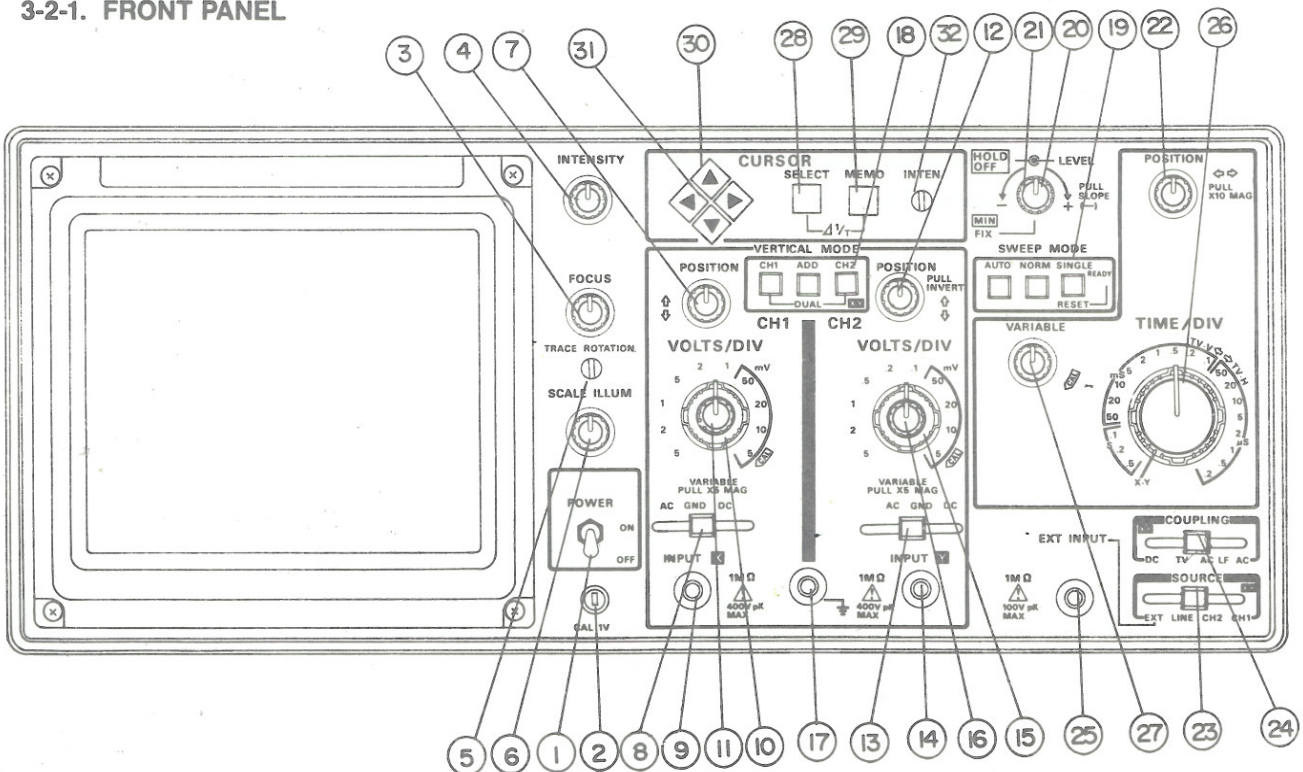

Fig. 8 FRONT PANEL

- ① POWER Switch — Turns instrument power on and off
- ② PROBE ADJUST 1Vp-p — Used for adjusting input capacitance of probe
- ③ FOCUS Control — Adjusts waveform display for optimum definition
- ④ INTENSITY Control — Adjusts brightness of the CRT trace line and point display
- ⑤ TRACE ROTATION Control — Operator-adjusted screwdriver control used to align the crt trace with the horizontal graticule lines. Once adjusted, it does not require readjustment during normal operation of the instrument unless it is moved to another location.
- ⑥ SCALE ILLUM Control — Adjusts the light level of the graticule illumination.
- ⑦ POSITION Control — Set vertical position of the channel 1 signal display
- ⑧ AC-GND-DC, Input Coupling Switches-Select the method of coupling input signals to the channel 1 Vertical attenuator
AC: Input signal is capacitively coupled to the vertical attenuator and the DC component of the input signal is blocked
GND: The input of the vertical amplifier is grounded to provide a zero (ground) reference voltage display
DC: All frequency components of the input signal are coupled to the vertical attenuator
- ⑨ CH1 INPUT & X Connector — Provide for application of external signals to the inputs of channel 1 vertical attenuator, X-Y operation: Input terminal for X-axis.
- ⑩ VOLTS/DIV Switch — Select vertical deflection factor settings in a 1-2-5 sequence with 10 positions for channel 1. The VAR control must be in the detent (fully clockwise) position to obtain a calibrated deflection factor.
- ⑪ VARIABLE, PULL X5 MAG — Provide continuously variable, uncalibrated deflection factors for Channel 1 between the calibrated settings of the VOLT/DIV switches and with pull-out position, the gain is magnified 5 times
- ⑫ POSITION PULL INVERT — Pulling out channel 2 position control switch, the polarity of channel 2 input signal is reversed such that positive input voltages cause downward deflection
- ⑬ AC-GND-DC Input Coupling Switches — Same function as No. 8 for channel 2
- ⑭ CH2 INPUT & Y Connector — Same function as No. ⑨ for channel 2 X-Y operation: Input terminal for Y-axis CH2.
- ⑮ VOLTS/DIV Switch — Same function as No. ⑩ for Channel 2
- ⑯ VARIABLE, PULL X5 MAG — Same function as No. ⑪ for Channel 2
- ⑰ $\frac{1}{2}$, Ground Jack — Provides an auxiliary signal ground when interconnecting equipment under test and the Oscilloscope
- ⑱ VERTICAL MODE Switches — Select the indicated channel(s) for display. Any combination of the possible signal selections can be displayed by pressing in the appropriate push buttons
CH1 : Channel 1 input signal only when pushed in
CH2 : Channel 2 input signal only when pushed in
ADD : The algebraic sum of channel 1 and channel 2 is displayed when pushed in. When both ADD pushed in and INVERT knob pulled out, the waveform displayed is the difference between CH1 and CH2
DUAL : Each input signal of channel 1 and channel 2 can be displayed when both pushed in. Both channels are chopped at about 250KHz from 0.5S/DIV to 1mS/DIV and both channels are switched alternately from 0.5mS/DIV to 0.2uS/DIV
- ⑲ SWEEP MODE Switch — Select the trigger mode.
AUTO : Sweep free runs in the absence of a triggering signal. The triggering level changes only when the LEVEL control is adjusted to a new position
NORM : Sweep is triggered and runs when a triggering signal compatible with the LEVEL setting is applied.
SINGLE : Push to reset. The sweep runs one or more times to produce a single sweep of each of the traces defined by the controls. Each sweep requires a distinct triggering event. The READY indicator remains illuminated until the final trace in the sequence is completed.
- ⑳ HOLD OFF Control — Varies the amount of holdoff time between the end of the sweep and the time a trigger can initiate the next sweep. Set this control fully counter clockwise for normal operation to give brightest display.
- ㉑ TRIG LEVEL Control — Sets the amplitude point on the triggering signal at which the sweep triggering occurs. This control produces fine resolution for a portion of its range.
- ㉒ Position, pull X10 MAG — Sets the horizontal position of the sweep displays on the CRT.
X10 MAG switch when pull out, horizontally magnifies the length of the sweep display by a factor of 10.

- ②③ SOURCE Switch — Selects the trigger signal source for the sweep CH1, CH2: A triggering signal is obtained from the corresponding vertical channel.
- LINE : A triggering signal is obtained from a sample of the AC power-source waveform. This trigger source is useful when vertical input signals are time related to the frequency of the AC power-source voltage
- EXT : A trigger signal is obtained from an external waveform.
- ②④ COUPLING Switch — Selects the method of coupling the triggering signal to the trigger generator circuit
- DC : All frequency components of the signal are coupled to the trigger generator circuitry. This coupling method is useful for triggering on most signals
- AC : Signals are capacitively coupled. Frequency components below 10 Hz are attenuated, and the DC component of the input signal is blocked. This coupling method is useful for signals that are super imposed on slowly changing DC voltage
- HF REJ : Attenuates high-frequency triggering signal components above 50 KHz. This coupling method is useful for eliminating radio frequency interference and high frequency noise components from the signal applied to the trigger generator circuitry
- TV : TV or Video composite signals are coupled to trigger generator circuitry.
SEC/DIV switch selects TV-V (Frame) and TV-H (Line) for accurate synchronization. The most important waveform in TV servicing is the composite signal consisting of the video signal, the blanking pedestals and sync pulses.
- ②⑤ EXT INPUT: External trigger signal input connector
- ②⑥ SEC/DIV Control — Selects 20 calibrated sweep speeds from 0.2 μ S to 0.5S per division in a 1-2-5 sequence. Extreme counterclockwise switch rotation selects X-Y display mode. In X-Y, the signal applied to the CH1 or X input connector drives the horizontal deflection system.
- ②⑦ VARIABLE Control — Continuously varies the sweep speed between settings of the SEC/DIV switch. Fully counterclockwise rotation extends the sweep speed of the slowest SEC/DIV switch setting (0.5S per division) to 1.25S per division and fully clockwise rotation produces the sweep speed indicated by the position of the SEC/DIV switches
- ②⑧ REF/ Δ Cursor selection switch — Cursor select switch provides selecting of either REF Cursor (X) or Δ cursor (\boxtimes). Pushing the switch, the selected cursor is brighten. It can be moved upward or downward and rightward or leftward on CRT. Also tracking is possible moving both rightward and leftward when the two Cursors are brighten.
- ②⑨ Cursor Memory Switch — When "CR 1" displayed on the upper left, the Cursor memory 1 function is being operated. "CP 2" displayed on the down right explains that cursor memory 2 function is being operated.
- ③① Cursor Movement Switch/READOUT Off Switch — By pushing the Movement Switch, the Cursor line moves arrow remarked when four switches are pushed simultaneously point ③①(push all cursor movement switch simultaneously) READOUT function is turned off. Push any movement switch again, and READOUT function is turned on again.
- ③② Inten — Adjust the brightness of Cursor and characters displayed on the CRT, and turn clockwise, the brightness increases.

3-2-1. REAR PANEL

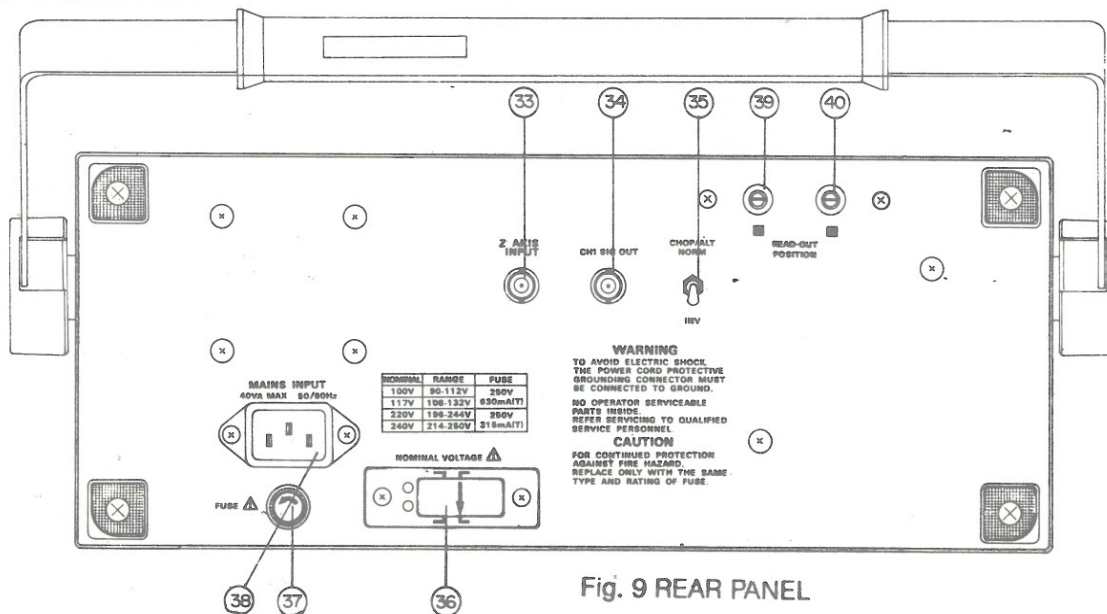

Fig. 9 REAR PANEL

- ③③ Z AXIS INPUT Connector — provides an input connection point to apply external Z-axis modulation signals to the Z-Axis Amplifier. Either the sweep or X-Y display may be intensity modulated.
- ③④ CH1 SIG OUT Connector — Provides an output signal that is a normalized representation of the channel 1 input signal.
- ③⑤ CHOP/ALT — CHOP/ALT function is operated by TIME/DIV switch in the NORM position, and always being operated as ALT state in no-relation with TIME/DIV switch in the INV position.
- ③⑥ VOLTAGE SELECTOR Switch — Selects the nominal instrument operating voltage range.
- ③⑦ FUSE HOLDER — Contains the AC power-source fuse
- ③⑧ RECEPTACLE — Detachable power cord receptacle provides the connection point for the AC power source to the instrument
 READ OUT FUNCTION — Horizontal axis position adjustment VR.
 READ OUT FUNCTION — Vertical axis position adjustment VR.
 HANDEL (OPTION)

3-3. TRIGGERING

This model has 4 knobs to control triggering. They are LEVEL, SLOPE, COUPLING and SOURCE.

SOURCES

When the vertical input signal is supplied to the internal SYNC circuit, it is called INTERNAL TRIGGER. When the same signal or integral number related signal is applied into the SYNC circuit through EXT TRIG input, it is referred to as EXTERNAL TRIGGER. In this model INT, CH-1 and CH-2 of SOURCE switch are internal triggers. The internal trigger signal is amplified in the vertical amplifier and triggering becomes easy.

LINE: The AC power line waveform is supplied to the SYNC circuit as a triggering source.

EXT: When SOURCE is turned to EXT, it becomes external trigger which has namely 3 benefits.

1. Triggering signal receives no effects from the vertical circuits.

Triggering level need not be readjusted when VOLTS/DIV knobs are turned because the source voltage changes. In such case, unless the external trig input voltage is changed, triggering is very stable and free from vertical controls.

2. Input signal can be easily delayed by the use of the delaying function of a pulse generator.
3. Composite signal or modulated signal can be easily triggered by the signal which composes the composite signal.

COUPLING

This switch has a selection of the sync circuit coupling. At AC position it becomes AC coupling and DC composite is isolated for stabilized synchronization. HF REJ has a low pass filter to eliminate RF noise interference to synchronization. At TV position either vertical or horizontal sync signal isolation circuit works to ensure TV signal triggering. Selection of TV-V or TV-H is done by SEC/DIV switch.

SLOPE

SLOPE switch+, -selects the triggering source signal slope of positive or negative.

When using TV mode, triggering point is set to sync pulse rising time or falling time.

LEVEL

Sets the amplitude point on the triggering waveform at which the time base is triggered.

3-4. X-Y OPERATION

This instrument is specially designed for easy X-Y application. Simply turn SEC/DIV switch to X-Y and use CH1 input for X-signals and CH2 for Y-signals.

3-5. CALIBRATED VOLTAGE MEASUREMENTS

Peak voltages, peak-to-peak voltages, DC voltages and voltages of a specific portion of a complex waveform can be measured using this instrument as a voltmeter. Voltages can be measured whenever waveforms are observed using either CH-1 or CH-2 inputs. Proceed as follows:

1. Set VARIABLE control fully clockwise to CAL position, then set VOLTS/DIV control to display the waveform in proper size to be observed. Vertical POSITION controls may be turned to obtain division reference.

2 For DC or complex signals, set AC-GND-DC to GND, and adjust the vertical POSITION control to a convenient reference level. Set AC-GND-DC to DC and observe the amount of deflection. A positive voltage will deflect trace upwards: a negative voltage will deflect the trace downward. To calculate the voltage reading, multiply the vertical deflection (by division) by the setting of the VOLTS/DIV switch.

NOTE WHEN A PROBE (10:1) IS USED, THE WAVEFORM DISPLAY IS ONLY 1/10 OF THE ACTUAL VOLTAGE MEASURED.

3-6. DUAL TRACE WAVEFORM OBSERVATION

MODE switch to be turned to DUAL. Other procedures are in the same manner as mentioned above.

3-7. TV SIGNAL SYNCHRONIZATION

Set COUPLING to TV, then specially designed circuitry provides easy triggering for complexed TV frame and line signal. TV frame and line waveform are easily obtained by simply turning SEC/DIV control.

3.8 ADD & SUBTRACT MEASUREMENTS

Simply turn vertical MODE switch to ADD, added waveform of CH-1 and CH-2 is displayed. With this MODE at ADD position, subtracted waveform is obtained by pulling INVERT knob which inverts the polarity of CH-2.

3-9. APPLICATIONS

This is a dual trace oscilloscope which has full capability of single trace mode. Thanks to the dual-trace functions, various effective measurements are feasible.

SINGLE-TRACE APPLICATIONS

Either Channel 1 or Channel 2 can be used for single-trace operation. Channel 1 is referred to hereunder for simplicity.

Set controls:

AC-GND-DC	AC
VERTICAL MODE	CH1
COUPLING	AC
SOURCE	CH1
PROBE	to CH-1 INPUT Jack

Connect the tip of the probe to the point in the circuit where the wave form is to be measured, and its ground clip to the chassis or the ground part.

CAUTION ! ! !

THE PEAK-TO-PEAK VOLTAGE AT THE POINT OF MEASUREMENT SHOULD NOT EXCEED 400 VOLTS.

3-9-1. AC VOLTAGE AND FREQUENCY MEASUREMENT

When measuring voltage and frequency, set VOLTS/DIV VARIABLES (4), (25) and SEC/DIV VARIABLE (9) at their calibrated detent points (clockwise).

(EX) The signal displayed on the CRT is

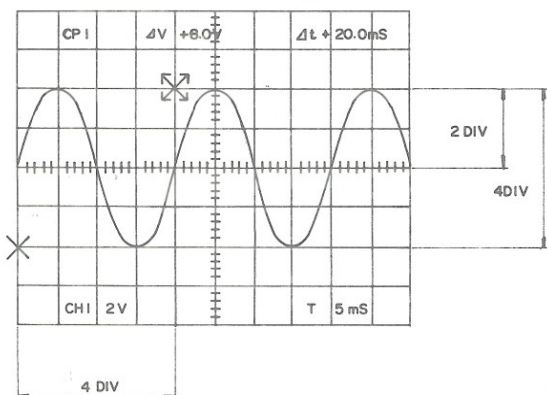

VOLT/DIV at 2V
SEC/DIV at 5 msec.

Fig.10.

- (a) Peak voltage $2\text{V/DIV} \times 2\text{DIV} = 4\text{ volts}$
 - (b) p-p voltage $2\text{V/DIV} \times 4\text{DIV} = 8\text{ volts}$
 - (c) Effective voltage (rms) $(\text{Peak voltage} \times \sqrt{2} = 2\text{V} \times 2\text{DIV}) / \sqrt{2}$
 $= 2.828\text{ volts}$
 - (d) Frequency (Hz) $1/\text{Time (second)}$
- ** Time = Number of DIVs for 1 cycle \times value of SEC/DIV

Therefore, the Fig. 10 waveform is:

Frequency = 1/time

$$\text{Frequency} = \frac{1}{5\text{m SEC} \times 4 (\text{DIV})} \times \frac{1}{20\text{m SEC}} = 50\text{Hz}$$

NOTE!!!

The input of this oscilloscope is $1\text{M}\Omega$ shunted by 20pF capacitance. When the probe is used in 10:1 attenuation, the impedance becomes $10\text{M}\Omega$ shunted by 10pF . Then the voltage reading must be multiplied by 10.

3-9-2. DC VOLTAGE MEASUREMENT

AC-GND-DC being at AC position, only AC or AC component was displayed on the CRT screen. For DC measurement, set the switch to GND and pull the LEVEL knob for a trace line, which must be positioned at a certain place as 0 volt reference.

After that, turn the switch to DC. Then the trace line shifts up or down. The value of movement is the DC voltage.

DC voltage = Shift (DIV) \times VOLTS/DIV

When the trace line shifts upward, the polarity is (+), and down-ward is (-).

3-9-3. AM MODULATION MEASUREMENT

There are various ways of measuring A.M. depth, here we suggest the envelope method. This method is applicable when the carrier frequency is within the frequency bandwidth of the oscilloscope. See Fig. 11.

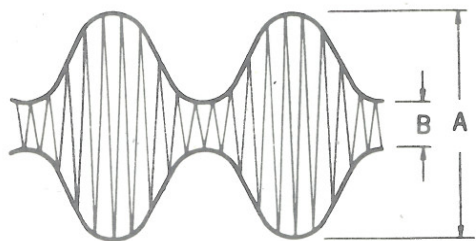

$$\text{Mod. (\%)} = \frac{A-B}{A+B} \times 100$$

Fig. 11.

3-9-4. DUAL-TRACE APPLICATIONS

Pressing MODE switches to DUAL. both Channel 1 and Channel 2 work simultaneously. Then, comparison of two relative signals is easily done such as level, waveforms, phase, etc.

3-9-5. LEVEL COMPARISON

OUTPUT/INPUT of an amplifier

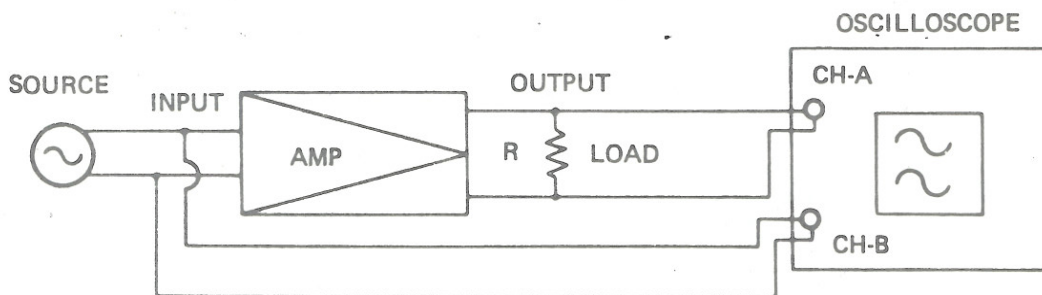

Fig. 12

With the connections shown in Fig. 12 set the displays of CH-1 and CH-2 the same (POSITION controls adjusted to place CH-2 waveform onto CH-1). Then the difference between displays of CH-1 VOLTS/DIV and CH-2's is the gain of the amplifier. If the two signals do not match each other even when variable controls are adjusted, the difference is the distortion caused in the amplifier. Then, simply turn the MODE switch to ADD and pull the CH-2 position knob for invert (SUB MODE), for viewing only distortion. When there is no distortion originated in the amplifier, a straight trace line is displayed in SUB MODE.

3-9-6. REPAIRING STEREO SYSTEMS

Every stereo equipment has two symmetrical amplifier circuits. So, simultaneous comparison of the same stages makes it so easy to locate defective point.

3-9-7. TV SERVICING

A triggered oscilloscope is indispensable. This model has the very convenient TV SYNC circuits of TV-V (Frame) and TV-H (line) for accurate synchronization to view VIDEO SIGNAL, BLANKING PEDESTALS, VITS and Vertical/Horizontal SYNC PULSES.

3-9-8. COMPOSITE VIDEO ANALYSIS

The most important waveform in TV servicing is the composite signal consisting of the video signal, the blanking pedestals, and sync pulses. Fig. 13 and Fig. 14 show composite signals synchronized with horizontal sync pulses and vertical blanking pulses.

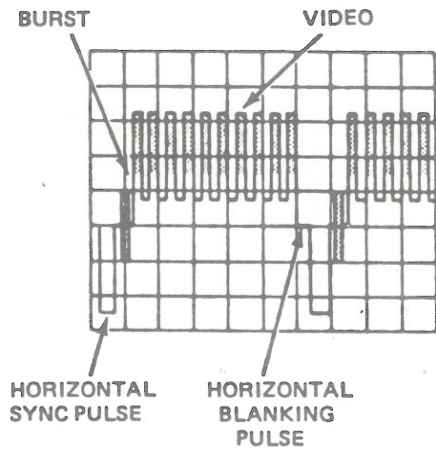

Fig. 13

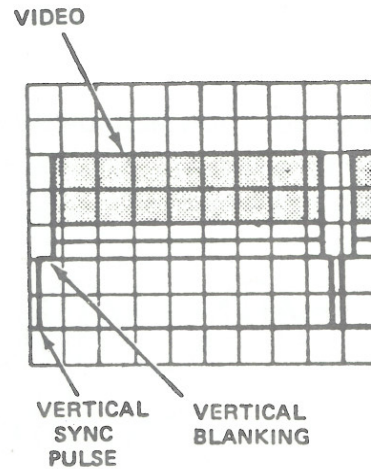

Fig. 14

3-9-9. MEASUREMENT OF FREQUENCY BY X-Y

Simply turn SEC/DIV switch for X-Y operation. Then CH-1 becomes X axis and CH-2 Y axis. Connect a standard frequency signal to CH-2 and unknown signal to CH-1. Lissajous figure is displayed on the screen as shown in Fig. 15.

Standard signal frequency: Unknown signal frequency

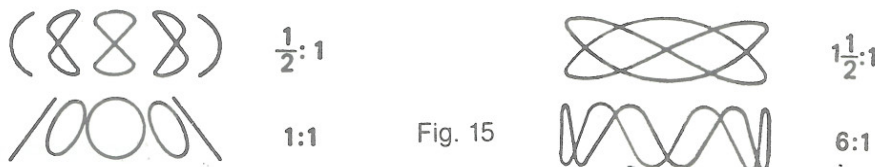
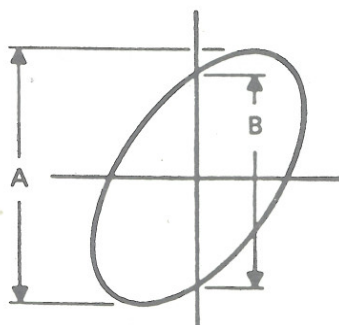

Fig. 15

3-9-10. PHASE MEASUREMENT

In X-Y function, apply two signals to each CH-1 and CH-2 Calculate according to the formula.



$$\text{SINE } \phi = \frac{B}{A}$$

ϕ = PHASE ANGLE

Fig. 16

3-9-11. READ-OUT DISPLAY

Adjust the intensity of the character and the focus appropriately in the READ OUT line.

1) Positions of the Display on CRT

Except for X, Y Mode, followings are displayed on CRT in any mode.

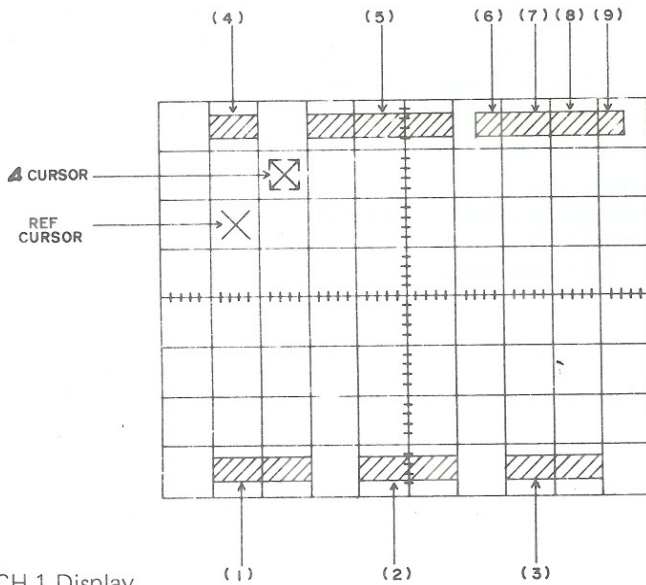
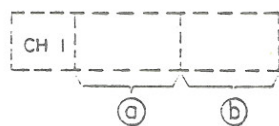

Fig. 17

(1) CH 1 Display

When in CH 1, ADD and Dual mode, "CH1" is displayed on CRT



- (a) Normal : BLANK
- X5 GAIN : "M"
- V/Div UNCAL : ">"
- (b) V/Div : 1mV ~ 5V

(2) CH 2 Display

When any one of Vertical mode switch CH 2, ADD, DUAL, is selected.

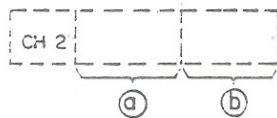

- (a) Normal : BLANK
- X5 GAIN : "M"
- V/Div UNCAL : ">"
- (b) V/Div : 1mV ~ 5V

(3) TIME Display

Time is displayed on CRT except the Time/Div switch is on X - Y mode.

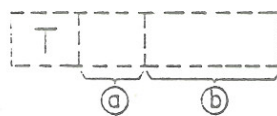

- (a) Normal : BLANK
- X10 MAG : "M"
- Time/Div UNCAL : ">"
- (b) Time/Div : 20mS ~ 0.5S

(4) Cursor Memory Display



- (a) Cursor memory number display: 1, 2
This displays cursor memory, number being worked on CRT

(5) Δ V Cursor Measured Value

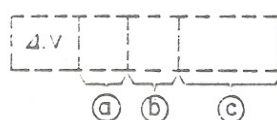

- (a) Measurement channel Display: 1, 2
- (b) Normal : BLANK
- V/Div UNCAL : ">"
- (c) Display of Cursor measured Value: ± 0.00mV ~ ± 40.0V

* NOTE

In case of ADD Mode, this is not displayed.

When V/Div of ch 1 is different from V/Div of CH 2

POLARITY Display: When the REF Cursor(X) is above the Δ Cursor (X) "+" is displayed.

(6) Δt Cursor Measured Value

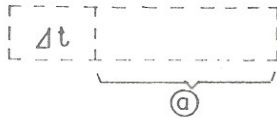

(a) Cursor measured value: 0.0nS ~ 5.00S

(7) Frequency ($\Delta 1/t$) Cursor Measured Value

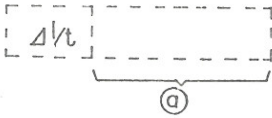

(a) Cursor measured Value Display: 0.200Hz ~ 1250.0MHz

(8) Ratio ($\Delta t\%$) Cursor Display

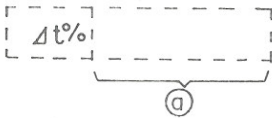

(a) Cursor Measured Value Display: 0.0% ~ 100.0%

(9) Phase (Δt°) Cursor Display

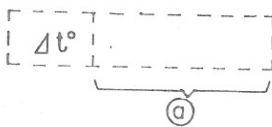

(a) Cursor Measured Value Display: 0.0° ~ 360.0°

SECTION 4 ADJUSTMENT AND CALIBRATION

Most of the problems resulting in a malfunction will be a defective component or a mechanical defect. Verify that the problem is not due to an incorrect switch position. The CRT display can be a valuable aid in pinpointing the area of many problems. The defect of any of the amplifiers, triggering circuit will be noticeable on the CRT.

4-1. MAINTENANCE

PREVENTIVE MAINTENANCE

Preventive maintenance consists of periodic cleaning, and recalibration of the oscilloscope. It should be performed on a regular bases to keep the instrument in its best operational and appearance condition.

CLEANING

Accumulation of dirt, dust and grime should be removed whenever they become noticeable. The frequency of cleaning is largely dependent upon the environment in which the instrument is used. Dirt on the outside covers may be removed with a soft cloth moistened with a diluted household cleaning solution.

RECALIBRATION

Recalibration of the instrument at regular intervals will assure that measurements are within the accuracy specification. It is recommended that the instrument be recalibrated after 1000 hours of operation, or twice a year. The calibration procedures are provided in the latter part of this section of the manual.

4-2. TEST EQUIPMENTS REQUIRED

- 1) Calibration Generator 0.2mV — 100V
- 2) Sine Wave Generator 25KHz — 100MHz
- 3) Time Mark Generator 5S — 5 μ S
- 4) Square Wave Generator 10Hz — 1MHz
- 5) Audio Oscillator 20Hz — 2MHz
- 6) Digital Multimeter DC 1000V
- 7) High Voltage Probe (High Impedance Probe) 10:1
- 8) Oscilloscope Probes
- 9) Oscilloscope (over 20MHz)

4-3. BASIC ADJUSTMENTS

4-3-1. POWER SOURCE

- 1) Adjust semi-fixed resistor (VR1006) to read +12.00V ($\pm 0.12V$) between the ground and Pin No. 2 of Connector P1005 in Vertical PCB (5504-01) assembly.
- 2) Verify if the voltage of each pin is as follows
P1005 Pin No. 3: -12V (-11.88V to -12.12V)
P1005 Pin No. 4: +5V (+5.00V to +5.15V)
P1005 Pin No. 6: +160V (+152V to +168V)

4-3-2. HIGH VOLTAGE CHECK

Verify that the voltage is within tolerance (-1950V to -2050V) between the ground and pin No. 3 of connector P2005 in Horizontal PCB (5504-02) assembly.

CAUTION

Make sure to use High Impedance Probe when measuring high voltage and be careful extremely to pin-point the measured parts.

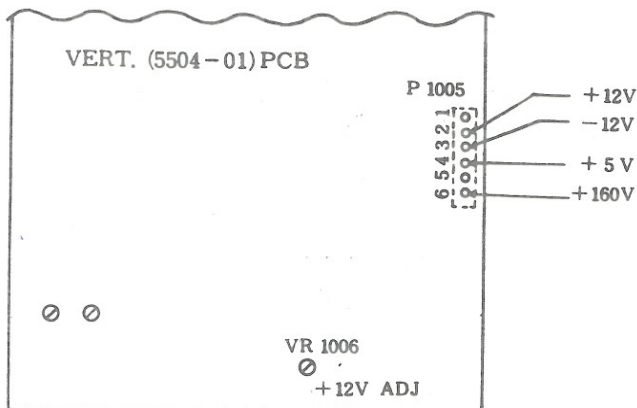

Fig. 18

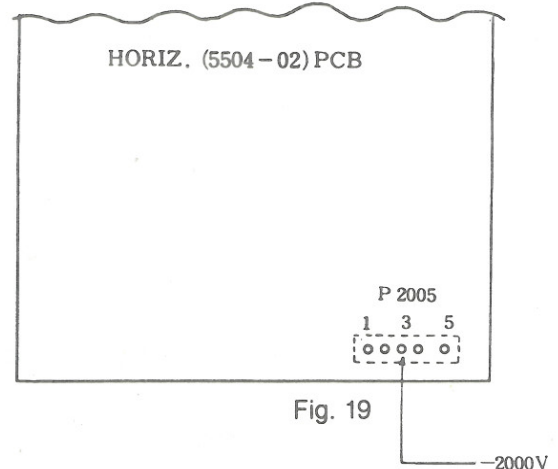

Fig. 19

4-4. CRT ADJUSTMENTS

4-4-1. Intensity

Put the INTENSITY control knob at the position of 10 O'clock and adjust semi-fixed resistor (VR3002, INTEN) in Horizontal PCB (5504-02) assembly until the trace line fades away.

4-4-2. Focus

Put the FOCUS control knob at center position and the SEC/DIV control knob at the X-Y position and then adjust semi-fixed resistor (VR2011, FOCUS) to get the optimum brightness of the spot.

4-4-3. Spot

After the above two steps, adjust semi-fixed resistor (VR2018, ASTIG) to make the spot a small circle.

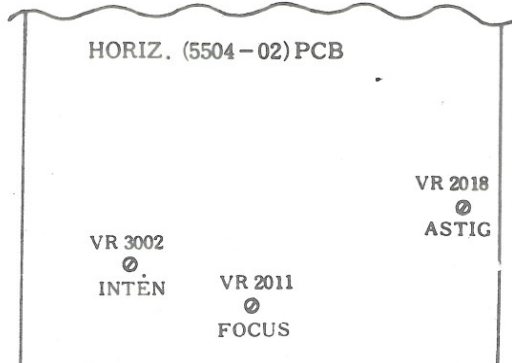

Fig. 20

4-5. VERTICAL ADJUSTMENTS

4-5-1. STEP BALANCE ADJUSTMENT

Adjust semi-fixed resistor (VR15, CH1) and (VR115, CH2) in Vertical PCB assembly to get a fixed line, without moving up and down when switching VOLTS/DIV knob over each range.

4-5-2. MAG (X5) BALANCE ADJUSTMENT

Adjust VR32 (CH1), VR132 (CH2) with the variable knob pull-out, X5 MAG position, until the trace line is without vertical movement.

4-5-3. VARIABLE BALANCE ADJUSTMENT

Adjust VR41 (CH1), VR141 (CH2) until the trace line is without vertical movement when turning the variable knob.

4-5-4. GAIN ADJUSTMENT

Preset
1KHz square wave source
Coupling: DC
VOLTS/DIV: 0.1V
VARIABLE: CAL

Input 500mV signal to CH1 and CH2 and adjust VR53 (CH1), VR153 (CH2) until the waveform is 5 divisions high.

4-5-5. MAG (X5) GAIN ADJUSTMENTS

Preset
Coupling: DC
VOLTS/DIV: 0.1V
VARIABLE KNOB (PULL×5 MAG): CAL

Input 0.1V square wave into CH1, CH2 and adjust VR30 (CH1), VR130 (CH2) until the waveform is 5 divisions high.

4-5-6. CH2 INVERT ADJUSTMENT

Set to dual vertical mode and 12 o'clock CH1, 2 position VR,
NORM — INV s/w of CH2 repeats, the trace line does not have to fluctuate when VR148 adjust CH 2 position VR does not have to out on 12 o'clock.
To center of CRT, trace line, VR 332 adjust.
To center of CRT, trace line, VR 48 adjust.
After vertical mode s/w sets to ADD position VR 163 adjust to center CRT, trace line

4-5-7. BAND BALANCE ADJUSTMENTS

Preset
VOLTS/DIV: 5mV
SEC/DIV: 0.2 μ S
Square wave: Rise time 1 μ S Apprx.

A. Mid-Band Adjustment

Input 1MHz square wave and control LEVEL to obtain 5 divisions and then adjust VR313, VC312 to get linear line from rise edge at the portion of 20 μ S.

B. High-Band Adjustments

Pull horizontal position switch to X10 MAG to extend the rise edge and adjust VR25 VC25 (CH1) and VR125 VC125 (CH2) until the over shoot and distortion are within specification.

C. Low-Band Adjustment

Input 100KHz square wave and adjust VR47 VC47 (CH1) and VR147 VC147 (CH2) to obtain the straightest line at the portion 10-70 μ S than the rise edge.

4-5-8. 1KHz SQUARE WAVE ADJUSTMENT

Rise time: Less than 1nS square wave
VOLTS/DIV: 0.1V and 1V

Adjust following trimmers to eliminate the over-shoots and under-shoots.

0.1V (1/10): VC5 (CH1), VC105 (CH2)
1V (1/100): VC8 (CH1), VC108 (CH2)

4-5-9. INPUT CAPACITY ADJUSTMENTS

Rise time: Less than 1 μ S square wave
VOLTS/DIV: 5mV
AC-GND-DC: DC

Input 1KHz signal to CH1 and CH2 with probe (10:1) and then adjust the trimmer to display the proper waveform.

With VOLTS/DIV switch to 0.1V and 1V, adjust the trimmers in Vertical PCB assembly as follows.

0.1V (1/10): VC4 (CH1), VC104 (CH2)
1V (1/100): VC7 (CH1), VC107 (CH2)

4-5-10. TRIG DC BALANCE ADJUSTMENTS

Input: 1KHz square wave
AC-GND-DC: DC
Vertical Mode: CH1 (CH2)
Wave Amplitude: 2 DIV
Coupling: AC

Turn LEVEL switch knob to position the triggering point at the center of wave and switch coupling to DC and adjust semi-fixed resistor VR73 (CH1), VR173 (CH2) until the triggering point does not move.

4-5-11. CH1 DC BALANCE ADJUSTMENT

VOLTS/DIV: 5mV
AC-GND-DC: GND
Vertical Mode: CH1

Set the CH1 Vertical position to display the trace line at the center of CRT and adjust semi fixed resistor VR 76 (CH OUT) until the LEVEL could be 0 Volt at 50 ohm from CH1 SIG OUT, rear panel.

4-5-12. X GAIN ADJUSTMENT

1KHz Accuracy: 0.3% square wave
CH1 VOLTS/DIV: 0.1V
SEC/DIV: X-Y
Vertical Mode: CH2
CH1 AC-GND-DC: DC
TRIG Coupling: DC

Adjust semi-fixed resistor VR7i (X-Y) to display the square wave of 5 DIV amplitude.

4-5-13. CH1 OUT GAIN ADJUSTMENT

VERT MODE: CH 1.2
CH1 COUPLING: DC
CH2 COUPLING: DC
CH1.2 VOLTS/DIV: 10mv

Use the 50 Ω termination at CH1 output terminal.

Coax cable connects to CH1 Input.

Source 10mV inputs to CH1 input amplitude of CRT has to become 5 DIV (VR 77 adjust).

4-6. HORIZONTAL TIME ADJUSTMENTS

4-6-1. TRIG'D ADJUSTMENT

Set to 12 o'clock position of TRIG LEVEL VR.

It's input to 1KHz sinewave.

When TRIG LEVEL VR push or pull, start position of trace line (Slope +, -) is in accord with start point (+, -) (VR413 adjustment)

Next Times, to center start point, VR415 adjust.

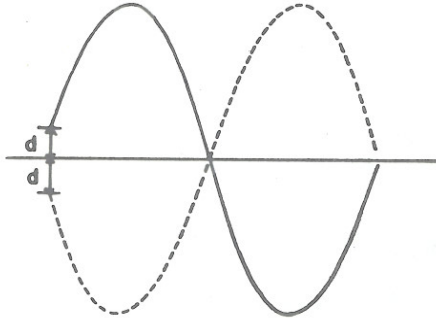

To maintain distance of d,
Adjust VR 413

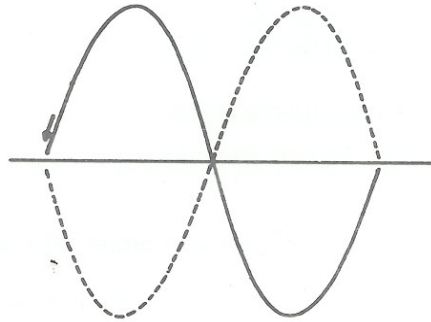

To center start point
Adjust VR 415

4-6-2. TRACE LINE START ADJUSTMENT

After Time Rotary switch turns to 0.1ms and Time position VR set at 12 o'clock.
Trace line have to start from the most left of screen (ADJUST point VR 805).

4-6-3. X-Y POSITION ADJUSTMENT (VR 414)

Time Rotary switch sets to X-Y position and the same of 1 phrase.
To center position of CRT VR414 has to adjust

4-6-4. TIME 1mS/1μS ADJUSTMENT

Time Marker: 1mS - 1μS

Vertical Mode: CH1

SEC/DIV: 1mS

Input Marker signal 1mS (pulse train) into CH1 and adjust semi-fixed resistor VR612 (A 1mS) until the signal can be on the graticule line.

Input Marker Signal into CH1 and switch SEC/DIV to 1μS/DIV and adjust semi-fixed resistor VR613 (A 1μS) until the signal can be on the graticule line.

4-6-5. SWEEP LENGTH ADJUSTMENT

VERT MODE: CH1

SEC/DIV: 0.1ms

Time Marker of 0.1ms inputs to CH1 INPUT

To sets sweep length 11.5 DIV VR614 adjust.

4-6-6. X10 MAG TIME ADJUSTMENT

VERT MODE: CH1

HORI POSITION: PULL AT x 10 MAG

HORI MODE: A

A SEC/DIV: 1ms

After Time Maker 0.1ms inputs to CH1 input, VR808 (H PCB) adjust that marker and marker must become 1 DIV.

4-6-7. X10 MAG CENTER ADJUSTMENT

Vertical Mode: CH1

SEC/DIV: 1mS

Input 1mS Marker signal to CH1 and pull the horizontal position knob (PULL x 10 MAG) and adjust VR806 (MAG CENT) until the balance can be maintained at the center of X axis.

4.7. FUNDAMENTAL ADJUST OF READOUT UNIT

- 1) Check whether the trace Rotation and Focus VR are properly adjusted
- 2) Push all Cursor **movement** switch keys simultaneously with pushing cursor select key and memo key at the same time.
- 3) Adjust cursor(X)(⊠) the same position as the following figure shown using VR1 – VR4

- VR1: Cursor's Horizontal length adjustment
- VR2: Horizontal Cursor position adjustment
- VR3: Cursor's Vertical length adjustment
- VR4: Vertical Cursor position adjustment

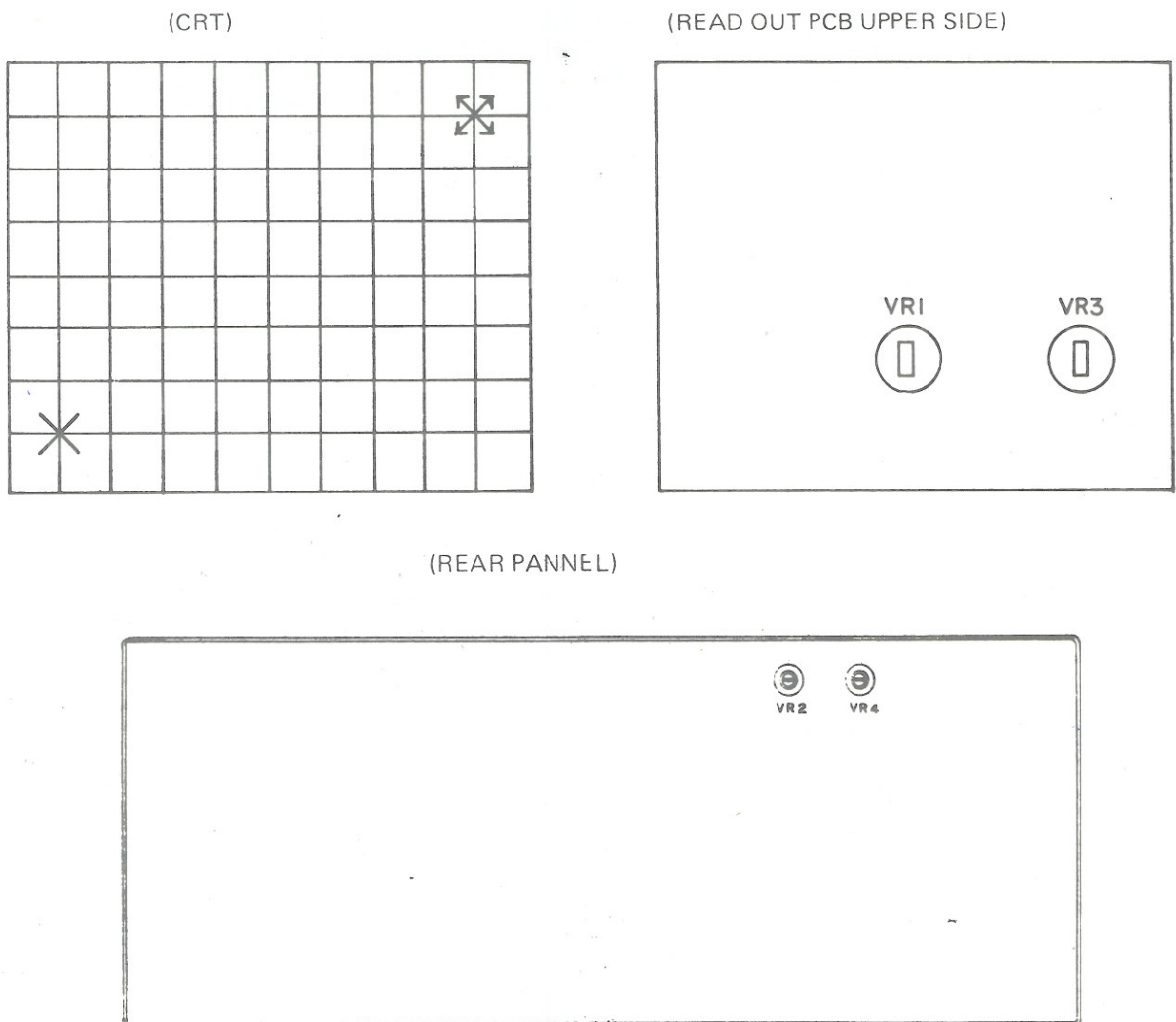

Fig. 23

SECTION 5. PARTS LIST
5-1. MECHANICAL PARTS

DESCRIPTION	SPECIFICATION	REF NO.	
2017-00000047	CARBON RESISTOR	RD25ST 47J	R1, 101
2017-00008200	CARBON RESISTOR	RD25ST 8.2KJ	R441
2820-10610008	POTENTION METER	610008	CH2, TIME POSI VOL
2820-10610009	POTENTION METER	610009	SWEEP VARIABLE VOL
2820-10610017	POTENTION METER	610017	CH1 POS VOL
2820-10610018	POTENTION METER	610019	LEVEL S/W VOL
3400-63022363	METAL FILM CAPACITOR	CF921L2J 630V 233KX	C2, 102
6010-00000423	SLIDE SWITCH	SSB-423	CH1-2 AC-GND-DC S/W
6010-00007201	TOGGLE SWITCH	MT-7201	
9002-31013201	FRONT PANEL	SBHG 1.2t	
9003-31002101	MODE S/W FRAME	sPC1 t1.6	FRONT PANEL SPOTING
9004-31002001	CRT FRONT HOLDER	SPC1 t1.2	FRONT PANEL SPOTING
9004-31004001	SHIELD COVER	C2600-1/2H t0.3	OPTION
9004-31015201	BRACKET SLIDE S/W(1)	SPC t1.0	
9004-31016401	BRANKET-SLIDE S/W(2)	SPC1 t1.0 SBHG	FRONT PANEL SPOTING
9102-31001501	FRONT FRAME	ABS+GLASS	
9102-81001101	BEZEL	NYLON6 GLASS30%	
9103-81000601	KNOB (6)	ABS	TIME
9104-81000101	KNOB (1)	ABS	V.R
9104-81000201	KNOB (2)	ABS	HOLD OFF
9104-81000301	KNOB (3)	ABS	LEVEL
9104-81000401	KNOB (4)	ABS	ATT
9104-81000501	KNOB (5)	ABS	V-VARIABLE
9104-81000701	KNOB (7)	ABS	LEVER S/W
9104-81000801	KNOB (8)	ABS	PUSH S/W
9104-81003901	SELECTOR COVER	P,C	
9203-81005701	TOP PLATE	POLYCARBONATE 0.3t	
9204-81001601	NAMD PLATE	POLYCARBONATE 0.5T	
9303-31002301	SCALE-ILLUM	ACRYL	
9304-81004101	FILTER	ACRYL 1.5T	
9404-31002801	CUSHION (1)	SPONGY T2	
9404-31007801	CUSHION (4)	SPONGY T2	
9404-31010001	CUSHION (5)	SPONGY 2.0t	
9500-31011301	INSERT-SCALE	C26009-1/2H	
9504-30140053	BNC TERMINAL	BSBM NI/PL	
9504-31002201	LEVER S/W GUIDE	C3650B	
9504-31003501	KNOB INSERT (1)	C26009-1/2H	KNOB (5), (5) INSERT
9504-3103601	KNOB INSERT (2)	C26009-1/2H	KNOB (2) INSERT
9504-31003901	PUSH S/W POLE	C3650B	OPTION
9504-31009901	KNOB INSERT (5)	C26009-1/2H	KNOB(4)(6)(9)(10) INSERT
9700-10002003	PLAN WASHER	2.6Pi ZN/PL	SCALE ILLUM
9700-20007001	SPRING WASHER	7Pi Ni/PL	
9700-20009001	SPRING WASHER	9Pi Ni/PL	
9800-10002053	BIND SCREW	M2.6*5L ZN/PL	SLIDE S/W
9800-10002043	BIND SCREW	M3*4L ZN/PL	BRACKET SLIDE S/W(1)
9800-10003102	BIND SCREW	M3*10L Cr/PL	BEZEL
9800-20003061	BIND WASHER SCREW	M3*6L Ni/PL	MODE PCB+F/P
9800-30003062	OVAL SCREW	M3*6L Cr/PL	FRONT FRAME
9800-40002063	FLAT SCREW	M2.6*6 ZN/PL	SCALE ILLUM, LEVER S/W GUIDE.
9800-60003083	FALT TAPPING SCREW	M3*8L ZN/PL	FRNOT PANEL+FRAME
9800-70003034	SET SCREW	M3*3	KNOB
9800-70003044	SET SCREW	M3*4	KNOB
9800-70003064	SET SCREW	M3*6	KNOB
9800-80006003	HEXAGON NUT	M6 ZN/PL	
9800-80008003	HEXAGON NUT	M8 ZN/PL	

9900-21000034	TACK S/W KNOB	ABS+ACRYL, FOREIGN MATERIALS	TACK S/W
4010-00630250	FUSE	250V 630mA(5.2Pi*20)	
4020-30055001	POWER TRANS	PT-5500BK-M	
6010-00005002	TOGGLE SWITCH	MS500K	CHOP/ALT S/W
6010-00920801	SELECTOR	9208-01	
6010-00920901	SELECTOR	9209-01	
6020-00100174	AC INLET	NC-174C	
6020-00300075	FUSE HOLDER	F75	
9002-31000902	REAR PANEL	LAMINATE SHEET 1.0t	
9104-81003901	SELECTOR COVER	P.C	
9104-81004001	CORD REST	PP	
9504-30140052	BNC TERMINAL	BSBM NI/PL	
9504-31007401	SELECTOR COVER POLE	PCB-GRIP BSBM	
9700-1004001	PLAN WASHER	4Pi Ni/PL	POWER TRANS, CORD REST
9700-20004001	SPRING WASHER	4Pi Ni/PL	POWER TRANS
9700-3003001	TOOTHED LOCK WASHER	3Pi Ni/PL	LEAD WIRE GROUND
9800-10003082	BIND SCREW	M3*8L Cr/PL	LEAD WIRE GROUND
9800-10003102	BIND SCREW	M3*10L Cr/PL	AC INLET
9800-10004102	BIND SCREW	M4*10L Cr/PL	POWER TRANS, CRT HOLDER
9800-10004201	BIND SCREW	M4*20L Ni/PL	CORD REST
9800-60003063	BIND TAPPING SCREW	M3*6L Zn/PL	FRAME+R/P
9800-8003001	HEXAGON NUT	M3 Ni/PL	LEAD WIRE GROUND
9800-8004001	HEXAGON NUT	M4 Ni/PL	POWER TRANS
9900-20400202	TIE BAND	TA-1	
9900-90000001	MOUNT	DW-S	
9000-40003005	INSULATION BUSHING	PVC	HEAT SINK
9004-31002501	HEAT SINK (2)	C2600P-1/2H t0.5	
9004-31004101	SHIELD PLATE	C2600P-1/2H t0.3	
9004-31010401	SHIELD PLATE	C2600P-1/2H t0.3	
9004-31015801	HEAT SINK-1A	A5052 2t	
9004-31015901	HEAT SINK-1B	BSBM 0.8t	
9004-31016001	HEAT SINK-2A	A5052P 2t	
9004-31016101	HEAT SINK-2B	BSBM 0.8t	
9004-31016201	HEAT SINK-3	A5052P 2t	
9204-31008501	MYLAR SHEET (1)	MYLAR t0.2	
9204-31009101	MYLAR SHEET (2)	MYLAR t0.2	
9304-81006801	SHAFT-1	ACETAL	
9304-81006901	SHAFT-2	ACETAL	
9700-20003001	SPRING WASHER	3.2Pi Ni/PL	FRAME(2), (3) GROUND
9700-30004001	TOOTHED LOCK WASHER	4 Pi Ni/PL	FRAME(2), (3) GROUND
9800-10003051	BIND SCREW	M3*5L Ni/PL	FRAME(2), (3) GROUND
9800-10003081	BIND SCREW	M3*8 Ni/PL	HEAT SINK+SHAFT
9800-20003061	BIND WASHER SCREW	M3*6L Ni/PL	HEAT
9800-90002006	RIVER BIND	2.5Pi	HEAT SINK 1A+1B, 2A+2B
9900-20700101	LOCKING SPACER	KGLS-14S	
9003-31002701	HIGH VOLTAGE CASE	SPC t1.0	
9200-40100101	LABEL		DANGER HIGH VOLTAGE
9203-81002602	INSULATION SHEET	POLY t0.3	
9204-81005401	HIGH VOLTAGE SHEET(1)	VINYL t0.25	
9204-81005402	HIGH VOLTAGE SHEET(2)	VINYL t0.25	
9204-81005403	HIGH VOLTAGE SHEET(3)	VINYL t0.25	
9504-31007402	PCB GRIP	BsBM	
9700-20003001	SPRING WASHER	3.2Pi Ni/PL	H.V CASE GROUND
9700-20004001	SPRING WASHER	4Pi NI/PL	GRIP+FRAME(3)
9700-30003001	TOOTHED LOCK WASHER	3Pi Ni/PL	PCB+GRIP, H.V CASE
9800-10003061	BIND SCREW	M3*6L Ni/PL	PCB+GRIP, H'V' CASE
9900-20700101	LOCKING SPACER	KGLS-14S	
9900-40500101	HEAT SINK	OSH-2425-SP	
9900-80200101	SNAP RIVET	DASR 5070	
4010-01150311	C.R.T	150 BTB31	
4020-05100305	ROTATION COIL	050-1003-05	
6020-00213291	CRT SOCKET	1339-1	
9003-31001601	CRT HOLDER (1)	SPC t1.6	

9003-31001701	CRT HOLDER (2)	SPC t1.6	
9003-31007701	CRT SHIELD	FERMALLOY t0.2 (P.B.)	
9004-31003102	CRT EARTH PANEL	BECUP t0.2	
9404-31002901	RUBBER CUSHION (2)	RUSBER t3.0	
9404-31008901	CRT SHEET	URETHANE SPONCY T0.4	
9700-10003001	PLAN WASHER	3.2Pi Ni/PL	CRT FRAME (1)
9700-20003001	SPRING WASHER	3.2Pi Ni/PL	CRT FRAME (1)
9800-10003051	BIND SCREW	M3*5L Ni/PL	CRT EARTH PANEL
9800-10003101	BIND SCREW	M3*10L Ni/PL	CRT FRAME (1)
9800-10003201	BIND SCREW	M3*20L Ni/PL	CRT HOLDER
9900-20400201	TIE BAND	TY26M	
9003-31003201	UPPER CASE	L AMINATE SHEET T1.0	
9003-31003301	LOWER CASE	LAMINATE SHEET T1.0	
9004-31009801	STAND	SBPR 5.0	
9104-81004201	MOLD FOOT	POM(ACETAL)	
9404-30240039	RUBBER LEG	RUBBER	
9700-10003001	PLAN WASHER	3.2Pi Ni/PL	RUBBER LEG
9800-10003101	BIND SCREW	M3*10L Ni/PL	RUBBER LEG
9800-10004102	BIND SCREW	M4*10L Cr/PL	MOLO FOOT
9800-20003062	BIND WASHER SCREW	M3*6L Cr/PL	UPPER CASE.LOWER CASE
9900-70300401	PLASTIC LEG	PLASTIC TM-127 NO. 1	
9004-31008701	HANDLE SPRING PLATE	SPS T0.5	
9004-31008801	HANDLE SUPPORT	SPC Ni/PL	
9104-31008601	HANDLE GRIP	PVC	
9800-30004122	OVAL SCREW	M4*12L Cr/PL	HANDLE SUPPORT
9800-80004001	HEXAGON NUT	M4 Ni/PL	HANDLE SUPPORT
9002-31001102	FRAME (2)	SBHG t1.2	
9002-31001202	FRAME (3)	SBHG t1.2	
9003-31001002	FRAME (1)	SBHG t 1.2	
9003-31001302	FRAME (4)	SBHG t 1.2	
9003-31001402	FRAME (5)	SBHG t 1.2	
9004-31014001	READOUT CPU FRAME (1)	SPC1 t1.2	
9004-31014101	READ OUT CPU FRAME(2)	SPC1 t1.2	
9800-10030601	BIND SCREW	M3x6L Ni/PL	CPU FRAME
9800-200030601	BIND WASHER SCREW	M3x6L Ni/PL	CPU PCB + CPU FRAME
9900-20400202	TIE BAND	TA-1	
6040-00001170	POWER CORD	UL-117	OPTION
6040-00002200	POWER CORD	W-220	OPTION
6040-00002201	POWER CORD	W-220	
6040-00002401	POWER CORD	A-240	OPTION
6041-00000020	TEST PROBE	OP-20	
6042-00550201	INSTRUCTION MANUAL	5206	
9600-90010020	SILICAGEL	20g	
9602-32000201	FRONT SNOW BOX	STYROFORM	
9602-32000301	REAR SNOW BOX	STYROFORM	
9603-32000901	INNER BOX	3	
9603-32001001	OUT BOX	3	
9603-91000401	PS BAG	PE t0.1	
6030-00506010	CONNECTOR WIRE/LEAD	50601	CPU(P1)---CURSOR(P1)
6030-00506020	CONNECTOR WIRE/LEAD	50602	CPU(P2)---V PCB(P2)
6030-00506030	CONNECTOR WIRE/LEAD	50603	CPU(P3)---V PCB(CH-2 ATT)
6030-00506040	CONNECTOR WIRE/LEAD	50604	CPU(P4)---V PCB(CH-1 ATT)
6030-00506050	CONNECTOR WIRE/LEAD	50605	CPU(P6)---MODE(J6)
6030-00506060	CONNECTOR WIRE/LEAD	50606	CPU(P7)---V PCB(P7)
6030-00506070	CONNECTOR WIRE/LEAD	50607	CPU(P8)---TIME MAG S/W
6030-00506080	CONNECTOR WIRE/LEAD	50608	CPU(P9)---TIME VARI S/W
6030-00506090	CONNECTOR WIRE/LEAD	50609	CPU(P10)---TIME SEC/DEV S/W
6030-00506100	CONNECTOR WIRE/LEAD	50610	CPU(P11)---TIME PCB(P11)
6030-00506110	CONNECTOR WIRE/LEAD	50611	CPU(P12)---TIME PCB(P12)
6030-00506120	CONNECTOR WIRE/LEAD	50612	V/ATT(P12-1, 13-2)-----
			V PCB(P13-1, 13-2)
6030-00506140	CONNECTOR WIRE/LEAD	50614	V PCB(P1)---MODE(J1)
6030-00506150	CONNECTOR WIRE/LEAD	50615	V PCB(P101)---MODE(J101)

6030-00506160	CONNECTOR WIRE/LEAD	50616	CRT SOCKET---TIME (P803)
6030-00506170	CONNECTOR WIRE/LEAD	50617	CRT SOCKET(Y+,Y-)---V PCB
6030-00506180	CONNECTOR WIRE/LEAD	50618	(P302)
6030-00506180	CONNECTOR WIRE/LEAD	50618	V PCB(P202)---MODE (J202)
6030-00506190	CONNECTOR WIRE/LEAD	50619	TIME (P601)---MODE (J601)
6030-00506210	CONNECTOR WIRE/LEAD	50621	(TIME. CPU)---GROUND
6030-00506220	CONNECTOR WIRE/LEAD	50622	H.V. CASE---HEAT SINK GROUND
6030-00550110	CONNECTOR WIRE/LEAD	55011	POWER TRANS---V/PCB(P1001)
6030-00550120	CONNECTOR WIRE/LEAD	55012	POWER TRANS---T/PCB(2004)
6030-00550130	CONNECTOR WIRE/LEAD	55013	CRT SOCKET---T/PCB(P2005)
6030-00550141	CONNECTOR WIRE/LEAD	55014-1	CH-1 OUT---V/PCB(P2)
6030-00550151	CONNECTOR WIRE/LAED	55015-1	Z-AXIS---T/PCB(P3001)
6030-00550160	CONNECTOR WIRE/LEAD	55016	CAL ---CAL/PCB(P4001)
6030-00550181	CONNECTOR WIRE/LEAD	55018-1	T/PCB(P401)---T/PCB(602) =
			P401---V/PCB(P102)
6030-00550190	CONNECTOR WIRE/LEAD	55019	V/PC(P201)---V/PCB(P301)
6030-00550201	CONNECTOR WIRE/LEAD	55020-1	V/PCB(P1003)---T/PCB(P2001)
6030-00550210	CONNECTOR WIRE/LEAD	55021	V/PCB(P1004)---T/PCB(P2002)
6030-00550220	CONNECTOR WIRE/LEAD	55022	T/PCB(P2003)---V/PCB(1005)
6030-00550230	CONNECTOR WIRE/LEAD	55023	V/PCB(P203)---T/PCB(P402)
6030-00550270	CONNECTOR WIRE/LEAD	55027	V/PCB(P1002)---CAL/PCB(P1002)
6030-00550281	CONNECTOR WIRE/LEAD	55028-1	T/PCB(P2006)---CRT SOCKET
6030-00550310	CONNECTOR WIRE/LEAD	55031	TIME POSITION---T/PCB(P810)
			V/R
6030-00550320	CONNECTOR WIRE/LEAD	55032	TIME POSITION---T/PCB(P802)
			S/W
6030-00550340	CONNECTOR WIRE/LEAD	55034	LEVAL V/R---T/PCB(P403)
			V/R
6030-00550350	CONNECTOR WIRE/LEAD	55035	LEVEL V/R---T/PCB(P406)
			SW
6030-00550360	CONNECTOR WIRE/LEAD	55036	TIME VARIABLE---T/PCB(P603)
6030-00550370	CONNECTOR WIRE/LEAD	55037	SCALE LAMP---CAL/PCB(P3002)
6030-00550400	CONNECTOR WIRE/LEAD	55040	EXT TRIC---TIME PCB(P405)
6030-00550410	CONNECTOR WIRE/LEAD	55041	CRT/PCB---V/PCB(P302, 303)
6030-00550420	CONNECTOR WIRE/LEAD	55042	V;T/PCB---GROUND
6030-00550430	CONNECTOR WIRE/LEAD	55043	V-PCB---GROUND
6030-00550440	CONNECTOR WIRE/LEAD	55044	TRANS---SELECTOR
6030-00550450	CONNECTOR WIRE/LEAD	55045	TRANS---SELECTOR
6030-00550460	CONNECTOR WIRE/LEAD	55046	TRANS---SELECTOR
6030-00550470	CONNECTOR WIRE/LEAD	55047	TRANS---SELECTOR
6030-00550480	CONNECTOR WIRE/LEAD	55048	TRANS---SELECTOR
6030-00550490	CONNECTOR WIRE/LEAD	55049	TRANS---SELECTOR
6030-00550530	CONNECTOR WIRE/LEAD	55053	SLIDE S/W---VERTICAL IN
6030-00550540	CONNECTOR WIRE/LEAD	55054	VOLTAGE SELECTOR
6030-00550550	CONNECTOR WIRE/LEAD	55055	AC SOCKET---FUSE HOLDER
6030-00550580	CONNECTOR WIRE/LEAD	55058	V/PCB(P203)---T/PCB(P42)
			CHOP S/W
6030-00550630	CONNECTOR WIRE/LEAD	55063	TIME PCB JUMP LEAD/WIRE
6030-00550650	CONNECTOR WIRE/LEAD	55065	POWER S/W---SELECTOR
6030-00550450	CONNECTOR WIRE/LEAD	55045	TRANS---SELECTOR
6030-00550460	CONNECTOR WIRE/LEAD	55046	TRANS---SELECTOR
6030-00550470	CONNECTOR WIRE/LEAD	55047	TRANS---SELECTOR
6030-00550480	CONNECTOR WIRE/LEAD	55048	TRANS---SELECTOR
6030-00550490	CONNECTOR WIRE/LEAD	55049	TRANS---SELECTOR
6030-00550530	CONNECTOR WIRE/LEAD	55053	SLIDE S/W---VERTICAL IN
6030-00550540	CONNECTOR WIRE/LEAD	55054	VOLTAGE SELECTOR
6030-00550550	CONNECTOR WIRE/LEAD	55055	AC SOCKET---FUSE HOLDER
6030-00550580	CONNECTOR WIRE/LEAD	55058	V/PCB(P203)---T/PCB(P42)
			CHOP S/W
6030-00550630	CONNECTOR WIRE/LEAD	55063	TIME PCB, JUMP LEAD/WIRE
6030-00550650	CONNECTOR WIRE/LEAD	55065	POWER S/W---SELEDSTOR

5-2. VERTICAL PCB ASS'Y

MAT'L CODE	DESCRIPTION	SPECIFICATION	REF NO.
1010-00003086	I.C	CA3086	IC2, 102
1010-00004558	I.C	UPC4558C	IC1001, 1002
1010-00007400	I.C	SN74LSOON	IC201
1010-00007474	I.C	SN74LS74N	IC202
1010-00013741	I.C	LF13741N	IC1, 101
1220-00002648	T.R	2SB648-A	Q309, 310
1220-00002711	T.R	2SA711	Q201, 202
1220-00002834	T.R	2SB834-Y	Q1001
1220-00002838	T.R	2SA838-B	Q7, 8, 9, 10, 107-8-9-10-11-12
1220-00002844	T.R	2SA844-D	Q3, 103, 203-4
1220-00002861	T.R	2SB861-C	Q1003
1220-00021005	T.R	2SA1005-L	Q5, 6, 105, 106
1230-00002668	T.R	2SD668-A	Q307, 308
1230-00002880	T.R	2SD880-Y	Q1002, 1004
1230-00002945	T.R	2SC945-Q	Q2, 4, 102, 104
1230-00021206	T.R	2SA1206-L	Q303, 304
1230-00021907	T.R	2SC1907	Q11, 301-2-5-6
1230-00022570	T.R	2SC2570	Q311, 312
1240-00021073	F.E.T	2SK107-3	Q1, 101
1330-00021907	DIODE	2SC1907	D1, 101
1330-00115880	DIODE	1S1588	D60, 61, 62, 63, 64, 65, 66, 67, 68, 69, 70, 71, 72, 75, 76, 77, 160, 161, 162, 163, 175, 176, 201, 202, 203, 204, 205, 206, 207, 208, 209, 215, 320, 321, 322, 323, 1004, 1019
1340-00000013	DIODE	RD13EL	D1003, 1011
1340-00000023	DIODE	HZ2B-3	D308, 309
1340-00000032	DIODE	HZ3C-2	D59, 159
1340-00000056	DIODE	RD5. 6EL3 (5.64-5.88V)	D1005
1340-00001441	DIODE	1G4B-41	D1001, 1002
2010-00000407	CARBON RESISTOR	RD25ST 4.7J	R30, 130, 317-18-26-27-28-29
2017-00000010	CARBON RESISTOR	RD25ST 10J	R10, 23-4, 80, 110-23-4, 251-2-3-4, 319-30-51-2-3, 1015
2017-00000015	CARBON RESISTOR	RD25ST 15J	R11- 111
2017-00000022	CARBON RESISTOR	RD25ST 22J	R44-5, 58, 71, 144-45, 161, 310-11
2017-00000027	CARBON RESISTOR	RD25ST 27J	R39, 40, 139, 140
2017-00000033	CARBON RESISTOR	RD25ST 33J	R3, 103
2017-00000047	CARBON RESISTOR	RD25ST 47J	R56-7, 79, 156, 157
2017-00000082	CARBON RESISTOR	RD25ST 82J	R171, 205-6, 331
2017-00000100	CARBON RESISTOR	RD25ST 100J	R14, 31, 48, 53, 114, 131, 148, 153, 1002, 1011, 1016
2017-00000120	CARBON RESISTOR	RD25ST 120J	R25, 26, 125, 126
2017-00000150	CARBON RESISTOR	RD25ST 150J	R46, 47, 146-7, 1021
2017-00000180	CARBON RESISTOR	RD25ST 180J	R51, 52, 151, 152
2017-00000200	CARBON RESISTOR	RD25ST 200J	R1017
2017-00000220	CARBON RESISTOR	RD25ST 220J	R75, 159, 163, 164, 174, 175, 312, 313
2017-00000270	CARBON RESISTOR	RD25ST 270J	R36, 136, 211
2017-00000390	CARBON RESISTOR	RD25ST 390J	R21, 121
2017-00000470	CARBON RESISTOR	RD25ST 470J	R212, 308, 309
2017-00000560	CARBON RESISTOR	RD25ST 560J	R1018
2017-00000680	CARBON RESISTOR	RD25ST 680J	R16, 29, 116, 129, 305, 306
2017-00000820	CARBON RESISTOR	RD25ST 820J	R77, 203, 204, 207
2017-00001000	CARBON RESISTOR	RD25ST 1KJ	R13, 15, 113, 115, 209, 210, 215 217, 218, 307, 324, 325
2017-00001200	CARBON RESISTOR	RD25ST 1.2KJ	R22, 49, 50, 122, 149, 150, 158
2017-00001500	CARBON RESISTOR	RD25ST 1.5KJ	R78
2017-00002200	CARBON RESISTOR	RD25ST 2.2KJ	R162

2017-00003300	CARBON RESISTOR	RD25ST 3.3KJ	R322, 323
2017-00003900	CARBON RESISTOR	RD25ST 3.9KJ	R17, 76, 117, 341
2017-00004700	CARBON RESISTOR	RD25ST 4.7KJ	R54, 55, 154, 155
2017-00005600	CARBON RESISTOR	RD25ST 5.6KJ	R19, 27, 28, 59, 119, 127, 128, 216, 1004, 1006, 1007
2017-00006800	CARBON RESISTOR	RD25ST 6.8KJ	R160
2017-00008200	CARBON RESISTOR	RD25ST 8.2KJ	R18, 118
2017-00010000	CARBON RESISTOR	RD25ST 10KJ	R208, 213, 214
2017-00018000	CARBON RESISTOR	RD25ST 18KJ	R334
2017-00022000	CARBON RESISTOR	RD25ST 22KJ	R314
2017-00047000	CARBON RESISTOR	RD25ST 47KJ	R32, 41, 132, 141, 335
2017-00100000	CARBON RESISTOR	RD25ST 100KJ	R1027
2017-01000000	CARBON RESISTOR	RD25ST 1MJ	R1025
2017-02200000	CARBON RESISTOR	RD25ST 2.2MJ	R1024
2020-00000202	CARBON RESISTOR	RD50ST 1/2W 2.2J	R1010
2027-00470000	CARBON RESISTOR	RD50ST 1/2W 470KJ	R12, 112
2114-00000025	METAL FILM RESISTOR	RSN 1/4W 25F	R94, 194
2114-00000040	METAL FILM RESISTOR	RSN 1/4W 40F	R97, 197
2114-00000056	METAL FILM RESISTOR	RSN 1/4W 56F	R37, 38, 137, 138
2114-00000060	METAL FILM RESISTOR	RSN 1/4W 60F	R 95, 195
2114-00000064	METAL FILM RESISTOR	RSN 1/4W 64F	R96, 196
2114-00000091	METAL FILM RESISTOR	RSN 1/4W 91F	R301, 302
2114-00000100	METAL FILM RESISTOR	RSN 1/4W 100F	R91, 93, 191, 193
2114-00000200	METAL FILM RESISTOR	RSN 1/4W 200F	R92, 192
2114-00000470	METAL FILM RESISTOR	RSN 1/4W 470F	R201-2, 303-4, 33-4, 133-4
2114-00000680	METAL FILM RESISTOR	RSN 1/4W 680F	R42, 43, 142, 143
2114-00001000	METAL FILM RESISTOR	RSN 1/4W 1KF	R73, 74, 172, 179
2114-00003900	METAL FILM RESISTOR	RSN 1/4W 3.9KF	R1022
2114-00009100	METAL FILM RESISTOR	RSN 1/4W 9.1KF	R1019, 1023
2114-00010100	METAL FILM RESISTOR	RSN 1/4W 10.1KF	R9, 109
2114-00012000	METAL FILM RESISTOR	RSN 1/4W 12KF	R1005, 1008
2114-00111000	METAL FILM RESISTOR	RSN 1/4W 111KF	R6, 106
2114-00120000	METAL FILM RESISTOR	RSN 1/4W 120KF	R1020
2124-00900000	METAL FILM RESISTOR	RK14B2H 1/2W 900KF	R5, 105
2124-00990000	METAL FILM RESISTOR	RK14B2H 1/2W 990KF	R8, 108
2124-01000000	METAL FILM RESISTOR	RK14B2H 1/2W 1MF	R4, 104
2237-00000001	METAL OXIDE RESISTOR	RS1B 1W 1J	R1001
2237-00000100	METAL OXIDE RESISTOR	RS1B 1W 100J	R1003, 1009, 1026
2237-00033000	METAL OXIDE RESISTOR	RS1B 1W 33KJ	R315, 316
2237-00043000	METAL OXIDE RESISTOR	RS1B 1W 43KJ	R320
2237-00047000	METAL OXIDE RESISTOR	RS1B 1W 47K	R321
2247-00001200	METAL OXIDE RESISTOR	RS2B 2W 1.2KJ	R1014
2810-00000100	SEMI FIXED RESISTOR	TM64K-3-PV2-100B	VR30, 71, 130
2810-00000500	SEMI FIXED RESISTOR	TM64K-3-PV2-500B	VR25, 47, 48, 125-47-48
2810-00001000	SEMI FIXED RESISTOR	TM64K-3-PV2-1KB	VR53, 73, 77, 153, 163, 173, 1006
2810-00002000	SEMI FIXED RESISTOR	TM64K-3-PV2-2KB	VR76, 313
2810-00010000	SEMI FIXED RESISTOR	TM64K-3-PV2-10KB	VR314
2810-00020000	SEMI FIXED RESISTOR	TM64K-3-PV2-20KB	VR15, 32, 41, 115, 132, 141, 332
2820-00001000	VARIABLE RESISTOR	10SA(C610020-1) 1KB	VR39, 139
2900-00004103	R NETWORK RESISTOR	RKL4-103F	RN201
3100-60000551	CERAMIC CAPACITOR	DD104CH 050D 50V 5PF	C25, 33, 34, 125, 133, 134
3100-60000751	CERAMIC CAPACITOR	DD104CH 070D 50V 7PF	C312
3100-60001051	CERAMIC CAPACITOR	DD104CH 100K 50V 10PF	C15, 115
3100-60001551	CERAMIC CAPACITOR	DD104CH 150K 50V 15PF	C20, 120
3100-60002251	CERAMIC CAPACITOR	DD104CH 220J 50V 22PF	C301, 302
3100-6002751	CERAMIC CAPACITOR	DD104CH 270K 50V 27PF	C308, 309
3100-6003351	CERAMIC CAPACITOR	DD105CH 330K 50V 33PF	C7, 107

3100-6004750	CERAMIC CAPACITOR	DD105CH 470J 50V 47PF	C334
3100-60004751	CERAMIC CAPACITOR	DD105CH 470K 50V 47PF	C71, 171
3100-60008251	CERAMIC CAPACITOR	DD107CH 820K 50V 82PF	C37, 38, 137, 138
3100-61010151	CERAMIC CAPACITOR	DD107CH 101K 50V 100PF	C31, 131
3100-61015151	CERAMIC CAPACITOR	DD107CH 151K 50V 150PF	C47, 147
3100-61022051	CERAMIC CAPACITOR	DD111CH 221K 50V 220PF	C39, 130, 139, 163
3100-61027151	CERAMIC CAPACITOR	DD112H 271K 50V 270PF	C10, 11, 110, 111
3100-61033151	CERAMIC CAPACITOR	DD112CH 331K 50V 330PF	C30
3100-6210251	CERAMIC CAPACITOR	DD104B 102K 50V 1000PF	C14, 18, 114, 118, 210
3100-6215251	CERAMIC CAPACITOR	DD104B 152K 50V 1500PF	C215
3100-62022213	CERAMIC CAPACITOR	DE7100F 222M VA1KV 2200PF	C1000
3100-63010350	CERAMIC CAPACITOR	DD106F 103Z 50V 10000PF	C17, 25, 51, 52, 58, 75, 117, 124, 151, 152, 161, 163, 175, 217,
3100-63010351	CERAMIC CAPACITOR	DD106F 103Z 50V 10000PF	218, 221, 254
3100-64010425	CERAMIC CAPACITOR	DD104CH 104Z 25V 100000PF	C331
3200-6401045	MYLAR CAPACITOR	501N5002 50V 104J	C335
3200-64047451	MYLAR CAPACITOR	501N5003 50V 474J	C332, 333
3400-63010351	METAL FILM CAPACITOR	ECQ-E4103KN(JNB) 103	C310, 311
3400-63022363	METAL FILM CAPACITOR	CF921L2J 630V 223KX	C317, 318
3400-63047322	METAL FILM CAPACITOR	CF921L2E 250V 473K	C320, 321
3500-00010050	ELECTRONIC CAPACITOR	RE-50V 1UF	C253
3500-00010051	ELECTRONIC CAPACITOR	RE-50V 2.2UF	C1013
3500-00010161	ELECTRONIC CAPACITOR	RE-160V 1UF	C330, 1018
3500-00100051	ELECTRONIC CAPACITOR	RE-50V 10UF	C23, 80, 123, 129, 351, 352
3500-00470025	ELECTRONIC CAPACITOR	RE-25V 47UF	C1002
3500-00470201	ELECTRONIC CAPACITOR	RE-200V 47UF	C1012
3500-01000025	ELECTRONIC CAPACITOR	RE-25V 100UF	C251, 252
3500-10000035	ELECTRONIC CAPACITOR	RE-35V 1000UF	C1001, 1010
3600-62022242	POLYPROPYLENE CAPACITOR	ECQ-M4222KZ 400V 222	C12, 112
3600-63022312	POLYPROPYLENE CAPACITOR	CQ92M2A 100V 223KB	C1024, 1025
3600-63047312	POLYPROPYLENE CAPACITOR	CQ92M2A 100V 473KB	C319
3700-50004700	CEMIKON CAPACITOR	CCM-C 0.47PM 0.47PF	C315, 316
3810-00060665	TRIMMER CAPACITOR	ECV-1ZW 06*65 6PF	VC5, 8, 105, 108
3810-00101065	TRIMMER CAPACITOR	ECV-1Z 10*65 10PF	VC4, 7, 105, 107
3810-00303065	TRIMMER CAPACITOR	ECV-1Z 30*65 30PF	VC25, 125, 312
3810-00505065	TRIMMER CAPACITOR	ECV-1Z 50*65 50PF	VC47, 147
4999-00000000	CARBON RESISTOR	RD25ST 0J	
6010-00201305	ROTARY SWITCH	09-93-05	S2, 102
6030-00504503	CONNECTOR WAFER	5045-03A(3P)	P1, 2, 13-1, 13-2, 102, 201, 301, 1003
6030-00504504	CONNECTOR WAFER	5045-04A(4P)	P12, 203
6030-00504505	CONNECTOR WAFER	5045-05A(5P)	P101, 1004
6030-00504506	CONNECTOR WAFER	5045-06A(6P)	P7, 202, 1005
6030-00504508	CONNECTOR WAFER	5045-08A(8P)	P1002
6031-00528705	CONNECTOR WAFER	5287-05A(5P)	P1001

5-3. HORIZONTAL PCB ASS'Y

MAT'L CODE	DESCRIPTION	SPECIFICATION	UNIT	Q'TY	REMARKS
1010-00000081	I.C	TL081CP	IC603		
1010-00004053	I.C	TC4053BP	IC602		
1010-00007400	I.C	SN74LSOON	IC401		
1010-00013741	I.C	LF1371N	IC2001		
1010-00074112	I.C	SN74LS112N	IC601		
1220-00002648	T.R.	2SB648-A	Q811,812		
1220-00002838	T.R.	2SA838-B	Q401,402,411,808		
1220-00021015	T.R.	2SA1015-Y	Q412,803,804		
1220-00028440	T.R.	2SA844-D	Q406,407,409,602,603,604,605 608,610-12,3009,3010		
1230-00002668	T.R.	2SD668-A	Q809,810		
1230-00002880	T.R.	2SD880-Y	Q2001		
1230-00002945	T.R.	2SC945-Q	Q609-13-14-16-17,801,802		
1230-00021843	T.R.	2SC1843-E	Q611		
1230-00021907	T.R.	2SC1907	Q404-5-13,601-15,805-6-7,3001, 3002		
1230-00022371	T.R.	2SC2371-L	Q3003-4-5-6		
1240-00002117	F.E.T	2SK117-BL	Q410,606,607,3007		
1240-00021073	F.E.T.	2SK107-3	Q403,414		
1330-00000021	DIODE	BAV21	D3018-19,3024		
1330-00000183	DIODE	1SS83	D822,3013-15-21-22		
1330-00000186	DIODE	1SS86	D433,601,819		
1330-00002620	DIODE	ERB26-20	D3025		
1330-00115880	DIODE	1S1588	D406-37-36,602-11-18-19-27-28 629-30-31-32-33-34		
1330-00115881	DIODE	1S1588	635.820-11-13-14-15-16, 820-21, 2001-8-9,3010-26-27,3029,3031, 3032,3033		
1340-00000016	DIODE	Y-16GA	D2010,2011		
1340-00000023	DIODE	HZ2B-3	D3008,3009		
1340-00000032	DIODE	HZ3C-2	D603		
1340-00000052	DIODE	HZ5C-2	D437		
1340-00000056	DIODE	RD5.6EL3 (5.64-5.88V)	D617,2006		
1350-20000226	L.E.D	TLG-226	D817,818		
2017-00000010	CARBON RESISTOR	RD25ST 10J	R451, 651		
2017-00000022	CARBON RESISTOR	RD25ST 22J	R602		
2017-00000033	CARBON RESISTOR	RD25ST 33J	R412, 440		
2017-00000047	CARBON RESISTOR	RD25ST 47J	R401, 405, 603, 827, 828		
2017-00000068	CARBON RESISTOR	RS25ST 68J	R414		
2017-00000100	CARBON RESISTOR	RD25ST 100J	R435-36, 622, 3012-13-15-36		
2017-00000120	CARBON RESISTOR	RD25ST 120J	R3002		
2017-00000220	CARBON RESISTOR	RD25ST 220J	R608, 3003		
2017-00000270	CARBON RESISTOR	RD25ST 270J	R434		
2017-00000330	CARBON RESISTOR	RD25ST 330J	R423, 601, 825-26, 3004		
2017-00000390	CARBON RESISTOR	RD25ST 390J	R433		
2017-00000470	CARBON RESISTOR	RD25ST 470J	R2009		
2017-00000510	CARBON RESISTOR	RD25ST 510J	R809		
2017-00000560	CARBON RESISTOR	RD25ST 560J	R421, 422, 637		
2017-00000680	CARBON RESISTOR	RD25ST 680J	R417-18-19-20, 3008, 3009		
2017-00000820	CARBON RESISTOR	RD25ST 820J	R813, 814		
2017-00001000	CARBON RESISTOR	RD25ST 1KJ	R431-38, 804-20, 35-36, 2006-14		
2017-00001200	CARBON RESISTOR	RD25ST 1.2KJ	R403, 605		
2017-00001500	CARBON RESISTOR	RD25ST 1.5KJ	R413, 441, 823, 824		
2017-00001800	CARBON RESISTOR	RD25ST 1.8KJ	R639, 3029		
2017-00002200	CARBON RESISTOR	RD25ST 2.2KJ	R404-7-28-37, 627, 819-20, 3027		
2017-00003300	CARBON RESISTOR	RD25ST 3.3KJ	R406-42, 623-24, 800, 804-5, 2007, 3014, 3028		

2017-00003900	CARBON RESISTOR	RD25ST 3.9KJ	R415, 416, 607
2017-00004700	CARBON RESISTOR	RD25ST 4.7KJ	R614, 2002, 3005
2017-00005600	CARBON RESISTOR	RD25ST 5.6KJ	R630, 801, 802, 3001
2017-00006800	CARBON RESISTOR	RD25ST 6.8KJ	R808
2017-00007500	CARBON RESISTOR	RD25ST 7.5KJ	R722
2017-00008200	CARBON RESISTOR	RD25ST 8.2KJ	R433
2017-00010000	CARBON RESISTOR	RD25ST 10KJ	R408-11-26-32, 610-12-17-28-33 634, 815-30-31, 2013, 3016
2017-00015000	CARBON RESISTOR	RD25ST 15KJ	R3030
2017-00018000	CARBON RESISTOR	RD25ST 18KJ	R606
2017-00022000	CARBON RESISTOR	RD25ST 22KJ	R427, 807
2017-00033000	CARBON RESISTOR	RD25ST 33KJ	R613
2017-00047000	CARBON RESISTOR	RD25ST 47KJ	R409, 439, 629, 638
2017-00056000	CARBON RESISTOR	RD25ST 56KJ	R625
2017-00082000	CARBON RESISTOR	RD25ST 82KJ	424-25, 611, 816-21;22, 2016, 3029
2017-00100000	CARBON RESISTOR	RD25ST 100KJ	R2017
2017-00150000	CARBON RESISTOR	RD25ST 150KJ	R2017
2017-00470000	CARBON RESISTOR	RD25ST 470KJ	R429-30, 609-21, 3026
2027-00022000	CARBON RESISTOR	RD50ST 1/2W 22KJ	R2010
2027-00047000	CARBON RESISTOR	RD50ST 1/2W 47KJ	R3006-7-10-11
2027-01500000	CARBON RESISTOR	RD50ST 1/2W 1.5MJ	R3017, 3018
2027-02200000	CARBON RESISTOR	RD50ST 1/2W 2.2MJ	R3023
2114-00000010	METAL FILM RESISTOR	RSN 1/4W 10F	R806
2114-00000470	METAL FILM RESISTOR	RSN 1/4W 470F	R618
2114-00001000	METAL FILM RESISTOR	RSN 1/4W 1KF	R402, 803, 810, 811
2114-00001600	METAL FILM RESISTOR	RSN 1/4W 1.6KF	R616
2114-00002000	METAL FILM RESISTOR	RSN 1/4W 2KF	R691
2114-00002200	METAL FILM RESISTOR	RSN 1/4W 2.2KF	R615
2114-00003900	METAL FILM RESISTOR	RSN 1/4W 3.9KF	R619
2114-00005000	METAL FILM RESISTOR	RSN 1/4W 5KF	R690
2114-00008200	METAL FILM RESISTOR	RSN 1/4W 8.2KF	R2004
2114-00010000	METAL FILM RESISTOR	RSN 1/4W 10KF	R689, 812
2114-00012000	METAL FILM RESISTOR	RSN 1/4W 12KF	R2003
2114-00018000	METAL FILM RESISTOR	RSN 1/4W 18KF	R631
2114-00020000	METAL FILM RESISTOR	RSN 1/4W 20KF	R688
2114-00033000	METAL FILM RESISTOR	RSN 1/4W 33KF	R632
2114-00050000	METAL FILM RESISTOR	RSN 1/4W 50KF	R687
2114-00068000	METAL FILM RESISTOR	RSN 1/4W 68KF	R2001
2114-00100000	METAL FILM RESISTOR	RSN 1/4W 100KF	R686, 817, 818
2114-00200000	METAL FILM RESISTOR	RSN 1/4W 200KF	R685
2114-00500000	METAL FILM RESISTOR	RSN 1/4W 500KF	R684
2114-01000000	METAL FILM RESISTOR	RSN 1/4W 1MF	R682, 683
2114-05000000	METAL FILM RESISTOR	RSN 1/4W 5MF	R681
2124-01000000	METAL FILM RESISTOR	RK14B2H 1/2W 1MF	R410
2124-02200000	METAL FILM RESISTOR	RK14B2H 1/2W 2.2MF	R2011
2237-00000001	METAL FILM RESISTOR	RS1B 1W 1J	R2008
2334-10000000	METAL FILM RESISTOR	CS1B 1W 10MF	R2012
2600-10000000	SOLID RESISTOR	RC 1/2 GF 10M	R3021, 3022, 3024, 3025
2810-00000100	SEMI FIXED RESISTOR	TM64K-3-PV2-100B	VR807
2810-00001000	SEMI FIXED RESISTOR	TM64K-3-PV2-1KB	VR415
2810-00005000	SEMI FIXED RESISTOR	TM64K-3-PV2-5KB	VR413, 414, 614, 806
2810-00020000	SEMI FIXED RESISTOR	TM64K-3-PV2-20KB	VR805, 3002, 612
2810-00100000	SEMI FIXED RESISTOR	TM64K-3-PV2-100KB	VR2018
2810-00500000	SEMI FIXED RESISTOR	TM64K-3-PV2-500KB	VR613
2810-02000000	SEMI FIXED RESISTOR	TM64K-3-PV2-2MB	VR2011
3100-60000351	CERAMIC CAPACITOR	DD104CJ 030C 50V 3PF	C433
3100-60001551	CERAMIC CAPACITOR	DD104CH 150K 50V 15PF	C615
3100-60002223	CERAMIC CAPACITOR	DD070SL 220K 2KV 22PF	C2015
3100-60004750	CERAMIC CAPACITOR	DD105CH 470J 50V 47PF	C601, 631
3100-60008251	CERAMIC CAPACITOR	DD107CH 820K 50V 82PF	C3004
3100-61010151	CERAMIC CAPACITOR	DD107CH 101K 50V 100PF	C606
3100-61015151	CERAMIC CAPACITOR	DD107CH 151K 50V 150PF	C408
3100-61018151	CERAMIC CAPACITOR	DD107CH 181K 50V 180PF	C414
3100-61033151	CERAMIC CAPACITOR	DD112CH 331K 50V 330PF	C3003

3100-62010251	CERAMIC CAPACITOR	DD104B 102K 50V 1000PF	C635
3100-62010263	CERAMIC CAPACITOR	DE110E 102Z 6KV 1000PF	C3014-15-17-18-22-23
3100-62015251	CERAMIC CAPACITOR	DD104B 152K 50V 1500PF	C2004
3100-62022251	CERAMIC CAPACITOR	DD105B 222K 50V 2200PF	C806
3100-62047233	CERAMIC CAPACITOR	DD11610E 472Z 3KV 4700PF	C2010-11-12-14
3100-63010351	CERAMIC CAPACITOR	DD106F 103Z 50V 10000PF	C406, 614, 3008-9-28
3100-63010352	CERAMIC CAPACITOR	DD104E 103P 500V 10000PF	C821-22-24-25-26, 2026, 3010, 3016
3200-62102051	MYLAR CAPACITOR	501N5002(K)50V 1000PF(102)	C411, 630
3200-63103051	MYLAR CAPACITOR	501N5002(K) 50V 1000PF (103)	C629
3200-63103101	MYLAR CAPACITOR	501N5003(K) 100V 10000PF (103)	C437
3200-63223051	MYLAR CAPACITOR	501N5002(K) 50V 22000PF (223)	C2022
3200-63223101	MYLAR CAPACITOR	501N5003(K) 100V 22000PF (223)	C409
3200-64104101	MYLAR CAPACITOR	501N5003(K)100V 100000PF (104)	C2006
3300-40000135	TANTAL CAPACITOR	SC-1V 105(M) 35V 1UF	C429, 2002
3400-62102101	METAL FILM CAPACITOR	ELQ-E-1102(J) 100V 1000PF	C607
3400-65105101	METAL FILM CAPACITOR	ECQ-K-1105(J) 100V (105P)	C608
3500-00010050	ELECTRONIC CAPACITOR	RE-50V 1UF	C652
3500-00100101	ELECTRONIC CAPACITOR	RE-100V 10UF	C2025
3500-00100500	ELECTRONIC CAPACITOR	RE-50V 10UF	C417-26-27,41-51, 603-17-51, 810, 2023-24, 3005, 3011
3500-00220051	ELECTRONIC CAPACITOR	RE-50V 22UF	C2008
3500-00470025	ELECTRONIC CAPACITOR	RE-25V 47UF	C424-25, 602, 611, 628
3500-01000025	ELECTRONIC CAPACITOR	RE-25V 100UF	C815
3500-02200016	ELECTRONIC CAPACITOR	RE-16V 220UF	C632
3500-02200025	ELECTRONIC CAPACITOR	RE-25V 220UF	C851
4010-20000002	NEON LAMP	NE-2	NE3001, 3002
4010-31101075	INDUCTOR	LF-7, 5 100UH	L2008
4030-06100251	CONVERTER TRANS	CF5500	
4999-00000000	CARBON RESISTOR	RD25ST OJ	
49999-0000004	JUMPER WIRE	4m/m	D813, 816
49999-0000007	JUMPER WIRE	7m/m	
49999-0000035	JUMPER WIRE	3.5m/m	
49999-0000070	JUMPER WIRE	70m/m LEAD WIRE	
6010-00201405	ROTARY SWITCH	02-014-05	S602
6010-06000031	LEVER SWITCH	SLR524 C600003-1	S401, 402
6030-00504503	CONNECTOR WAFER	5045-03A(3P)	602, 2001-6, 3001, 603, 801-2
6030-00504504	CONNECTOR WAFER	5045-04A(4P)	P11, 12, 401, 402
6030-00504505	CONNECTOR WAFER	5045-05A(5P)	P403, 601, 2002
6030-00504506	CONNECTOR WAFER	5045-06A(6P)	P406, 2003
6030-00528802	CONNECTOR WAFER	5288-02A(2P)	P2004
6030-00528805	CONNECTOR WAFER	5288-05A(5P)	P2005

5-4. CAL & CONTROL PCB ASS'Y

MAT'L CODE	DESCRIPTION	SPECIFICATION	REF NO.
1010-00004011	I.C	TC4011BP	IC4001
1230-00021846	T.R	2SC1846-R	Q3010, 3011
1340-00003620	DIODE	HZ36L-2	D3035, 3036, 3037
1350-20000342	L.E.D.	SLR-34MG(GREEN)	LD3035
2017-00000010	CARBON RESISTOR	RD25ST 10J	R4051
2017-00000100	CARBON RESISTOR	RD25ST 100J	R3034
2017-00000470	CARBON RESISTOR	RD25ST 470J	R4009
2017-00000680	CARBON RESISTOR	RD25ST 680J	R3035
2017-00002700	CARBON RESISTOR	RD25ST 2.7KJ	R3033
2017-00010000	CARBON RESISTOR	RD25ST 10KJ	R4001, 4002
2017-00043000	CARBON RESISTOR	RD25ST 43KJ	R4012
2017-00100000	CARBON RESISTOR	RD25ST 100KJ	R4003, 4004
2017-00150000	CARBON RESISTOR	RD25ST 150KJ	R4005
2017-00220000	CARBON RESISTOR	RD25ST 220KJ	R4006
2017-00470000	CARBON RESISTOR	RD25ST 470KJ	R4007, 4008
2114-00001000	METAL FILM RESISTOR	RSN 1/4W 1KF	R4011
2114-00010000	METAL FILM RESISTOR	RSN 1/4W 10KF	R4010
2820-20261001	VARIABLE RESISTOR	C610011-1-1 (2KB)	VR3036
2820-31061001	VARIABLE RESISTOR	C610010-1-1 (10KB)	VR3033, 3037
2820-40261001	VARIABLE RESISTOR	C610010-2-1 (200KB)	VR3035
3100-60000551	CERAMIC CAPACITOR	DD104CH 050D 50V 5PF	C4007
3100-62010251	CERAMIC CAPACITOR	DD104B 102K 50V 1000PF	C4009
3200-63010351	MYLAR CAPACITOR	501N5002(K)50V 10000PF (103)	C4001, 4002
3500-00470025	ELECTRONIC CAPACITOR	RE-25V 47UF	C4051
4020-25504030	CAL PCB	5504-03-00	
4999-00000000	CARBON RESISTOR	RD25ST OJ	
6030-00504504	CONNECTOR WAFER	5054-04A(4P)	P3002
6030-00504508	CONNECTOR WAFER	5045-08A(8P)	P1002

5-5. MODE PCB ASS'Y

MAT'L CODE	DESCRIPTION	SPECIFICATION	REF NO.	REMARKS
1330-00115880	DIODE	1S1588	D640	
1350-20000341	L.E.D.	SLR-34DU(ORANGE)	LD640	
2017-00010000	CARBON RESISTOR	RD25ST 10KJ	R640	
2820-61003310	VARIABLE RESISTOR	N20KC-10KB	CH-1	
2820-61003410	VARIABLE RESISTOR	S(PL)(SL123-4)20KC-10KB	CH-2	
2900-00004103	R NETWORK RESISTOR	RKL4-103F	RN701	
3100-62010251	CERAMIC CAPACITOR	DD104B 102K 50V 1000PF	C640	
3100-64010451	CERAMIC CAPACITOR	RD312BC 50V 104Z	C641	
4020-20103404	MODE S/W PCB	01-034-04		
4999-00000010	JUMPER WIRE	10m/m		
6010-06100151	PUSH S/W	SUF30 C610015-1	S201	
6010-06100161	PUSH S/W	SUF30 C610016-1	S601	
6030-00504603	CONNECTOR WAFER	5046-03A(3P)	J1	
6030-00504604	CONNECTOR WAFER	5046-04A(4P)	J6	
6030-00504605	CONNECTOR WAFER	5046-05A(5P)	J101, 601	
6030-00504606	CONNECTOR WAFER	5046-06A(6P)	J202	

5-6. CRT PCB ASS'Y

NO.	PARTS NO.	DESCRIPTION
2017-00000560	CARBON RESISTOR RD25ST 560J	R332,333
4010-30022075	INDUCTOR LF-7.5 2.2UH	L332, 333
4020-25504050	CRT PCB 290-1040-14	
6020-00213391	CRT SOCKET 1339-1	

Q2001

5-7. CPU PCB ASS'Y

OSH-2425-SP

REF NO.	PARTS NO.	DESCRIPTION
1010-00007402	I.C TC74HC02P	IC7
1010-00007805	I.C TA78L05P	IC9
1010-00074123	I.C TC74HC123	IC6
1010-00074244	I.C TC74HC244P	IC4
1010-00074374	I.C TC74HC374P	IC5
1012-00001010	I.C AX-1010	IC1
1220-00021015	T.R 2SA1015-Y	Q1, 2, 6, 7, 8, 9
1230-00021815	T.R 2SC1815-Y	Q3, 4
1330-00115880	DIODE 1S1588	D1, 2, 3, 4, 5, 6, 7, 8
2017-00000010	CARBON RESISTOR RD25ST 10J	R11, 22, 27
2017-00000022	CARBON RESISTOR RD25ST 22J	R1
2017-00000100	CARBON RESISTOR RD25ST 100J	R20, 21, 42
2017-00000270	CARBON RESISTOR RD25ST 270J	R10, 23, 24
2017-00000680	CARBON RESISTOR RD25ST 680J	R26, 31
2017-00000820	CARBON RESISTOR RD25ST 820J	R5
2017-00000910	CARBON RESISTOR RD25ST 910J	R15
2017-00001000	CARBON RESISTOR RD25ST 1KJ	R8, 18
2017-00002200	CARBON RESISTOR RD25ST 2.2KJ	R28, 30
2017-00003300	CARBON RESISTOR RD25ST 3.3KJ	R29, 32
2017-00003900	CARBON RESISTOR RD25ST 3.9KJ	R14, 16, 33
2017-00004700	CARBON RESISTOR RD25ST 4.7KJ	R4, 6
2017-00006800	CARBON RESISTOR RD25ST 6.8KJ	R7, 17
2017-00008200	CARBON RESISTOR RD25ST 8.2KJ	R9, 19
2017-00010000	CARBON RESISTOR RD25ST 10KJ	R34
2017-00022000	CARBON RESISTOR RD25ST 22KJ	R25
2017-00100000	CARBON RESISTOR RD25ST 100KJ	R43, 44, 45
2114-00000510	METAL FILM RESISTOR RSN 1/4W 510F	R2
2114-00001600	METAL FILM RESISTOR RSN 1/4W 1.6KF	R13
2114-00010000	METAL FILM RESISTOR RSN 1/4W 10KF	R3, 12, 46
2114-00020000	METAL FILM RESISTOR RSN 1/4W 20KF	
2114-00022000	METAL FILM RESISTOR RSN 1/4W 22KF	R35
2114-00039000	METAL FILM RESISTOR RSN 1/4W.39KF	R36
2114-00680000	METAL FILM RESISTOR RSN 1/4W 680KF	R41
2114-00750000	METAL FILM RESISTOR RSN 1/4W 750KF	R40
2810-00002000	SEMI FIXED RESISTOR TM64K-3-PV2-2KB	VR2, 4
2810-00005000	SEMI-FIXED RESISTOR TM64K-3-PV2-5KB	VR1, 3
2900-30050304	R NETWORK RESISTOR 4B73 50KF	RA5, 6
2900-30050308	R NETWORK RESISTOR 8B75 50KF	RA3, 4
2900-30100308	R NETWORK RESISTOR RAS8S 100KF	RA1, 2
3100-60003000	CERAMIC CAPACITOR DD105CH 300K 30PF	C13, 14
3100-60004751	CERAMIC CAPACITOR DD105CH 470K 50V 47PF	C28, 29, 30
3100-61010151	CERAMIC CAPACITOR DD107CH 101J 50V 100PF	C21, 22, 25, 26
3100-61027151	CERAMIC CAPACITOR DD112H 271K 50V 270PF	C17
3100-61022251	CERAMIC CAPACITOR DD105B 222K 50V 2200PF	C19
3100-64010425	CERAMIC CAPACITOR DD104CH 104Z 25V 100000PF	C4, 6, 9, 10-1-2-5-6-8, 20-3-4-7
3300-40000151	TANTAL CAPACITOR SC1V 105M-50V 1UF	C7
3500-40004716	ELECTRONIC CAPACITOR RE-16V 47UF	C1, 2, 3, 5, 8
3900-2001020	ARRAY CARACITOR CA1028J 1000PF	CA1
3900-21000120	CERAMIC OSC CSA 10.00MT (12MHz)	X1

4010-30010000	INDUCTOR	10UH	L1, 2, 3, 4, 5, 6, 7
4020-20102904	READOUT CPU PCB	01-029-04	
6030-00504503	CONNECTOR WAFER	5045-03A(3P)	P3, 4, 8, 9
6030-00504504	CONNECTOR WAFER	5045-04A(4P)	P2, 6, 10, 11
6030-00504505	CONNECTOR WAFER	5045-05A(5P)	P12
6030-00504506	CONNECTOR WAFER	5045-06A(6P)	P7
6030-00504509	CONNECTOR WAFER	5045-09A(9P)	P1

5-8. CURSOR PCB ASS'Y

REF NO.	PARTS NO.	DESCRIPTION
2810-00003810	SEMI FIXED RESISTOR EVM38G 10KB	VR11
4020-20103004	CURSOR PCB 01-030-04	
6010-00010903	TACT S/W SKE GAC (KEG10903)	
6030-00504509	CONNECTOR WAFER 5045-09A(9P)	
9000-00051703	KEY TOP CF51703, CF59609	

5-9. TIME ATT

REF NO.	PARTS NO.	DESCRIPTION
2114-00002000	METAL FILM RESISTOR RSN 1/4W 2KF	R144
2114-01000000	METAL FILM RESISTOR RSN 1/4W 1MF	R141, 142, 143
2900-10001000	R NETWORK RESISTOR RN1034F 5PIN 10KF	RN14
4020-20103204	TIME ATT S/W PCB 01-032-04	
6030-00504603	CONNECTOR WAFER 5046-03A(3P)	P14

5-10. V.CHI. 2 ATT

REF NO.	PARTS NO.	DESCRIPTION
2900-0401000	R NETWORK RESISTOR RN10210HF 11PIN 1KF	CH1:RN13, CH2:RN13
2900-10001000	R NETWORK RESISTOR RN1034F 5PIN 10KF	CH1:RN12, CH2:RN12
4020-20103104	CH-1,2 ATT S/W PCB 01-031-04	CH-1,2
6030-00504603	CONNECTOR WAFER 5046-03A(3P)	CH1-P12, CH2-P12
6030-00504604	CONNECTOR WAFER 5046-04A(4P)	CH1-P13, CH2-P13

SECTION 6. COMPONENTS LAYOUT

VERTICAL PCB UNIT

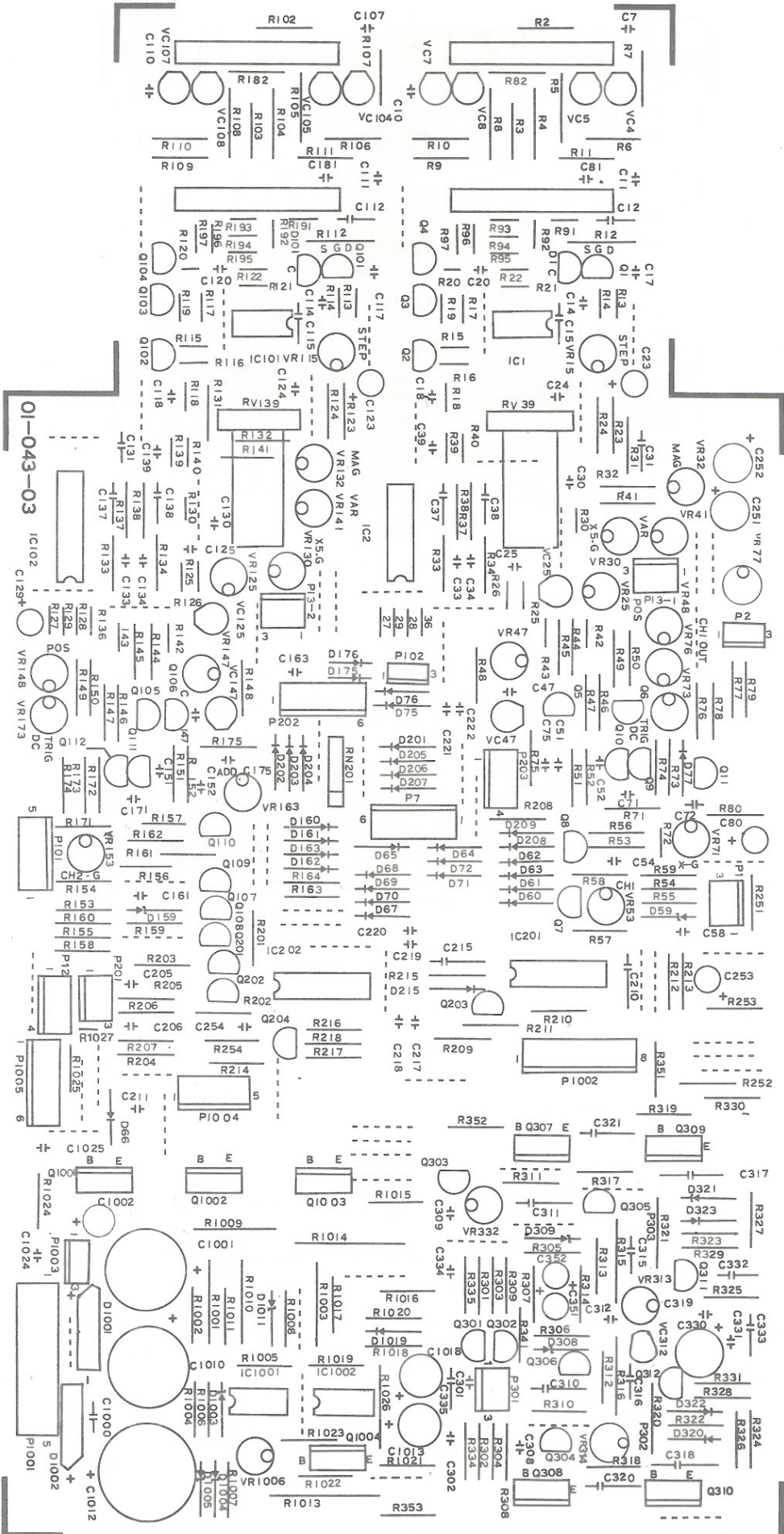

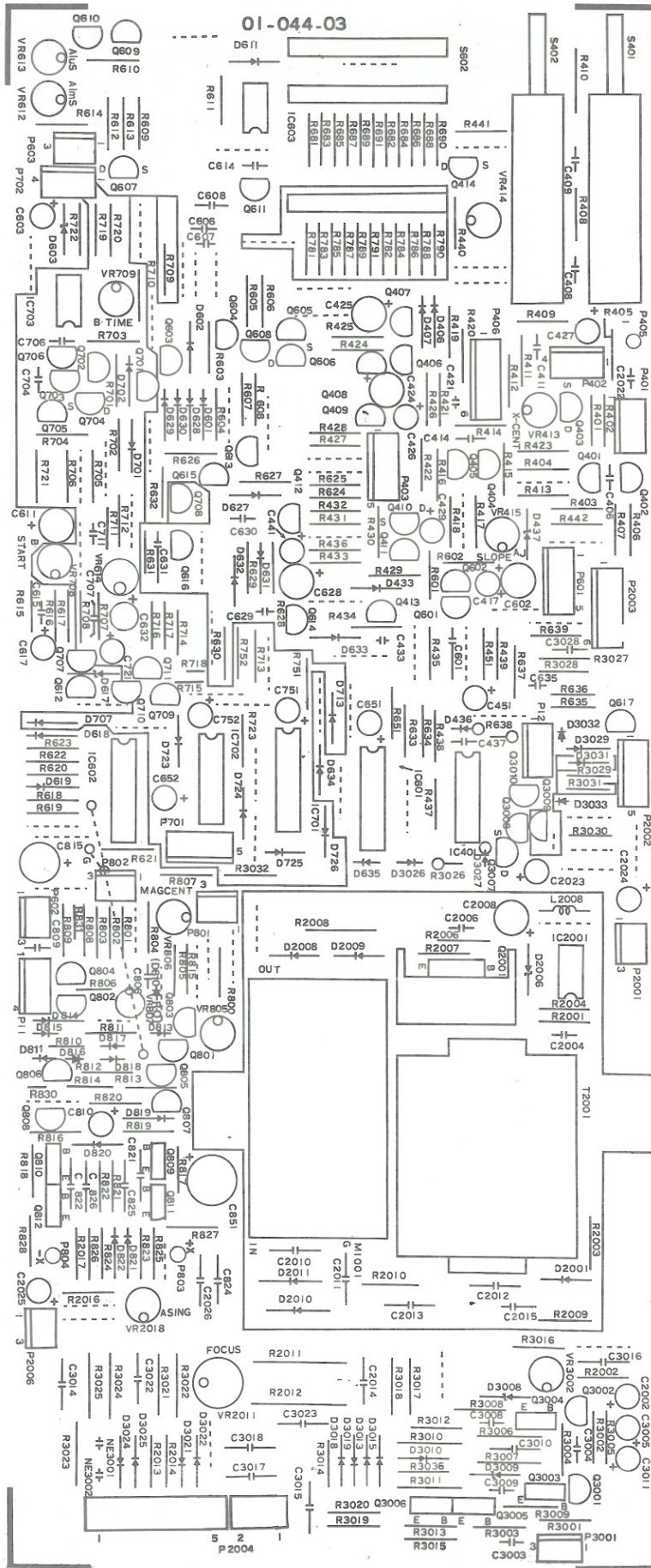

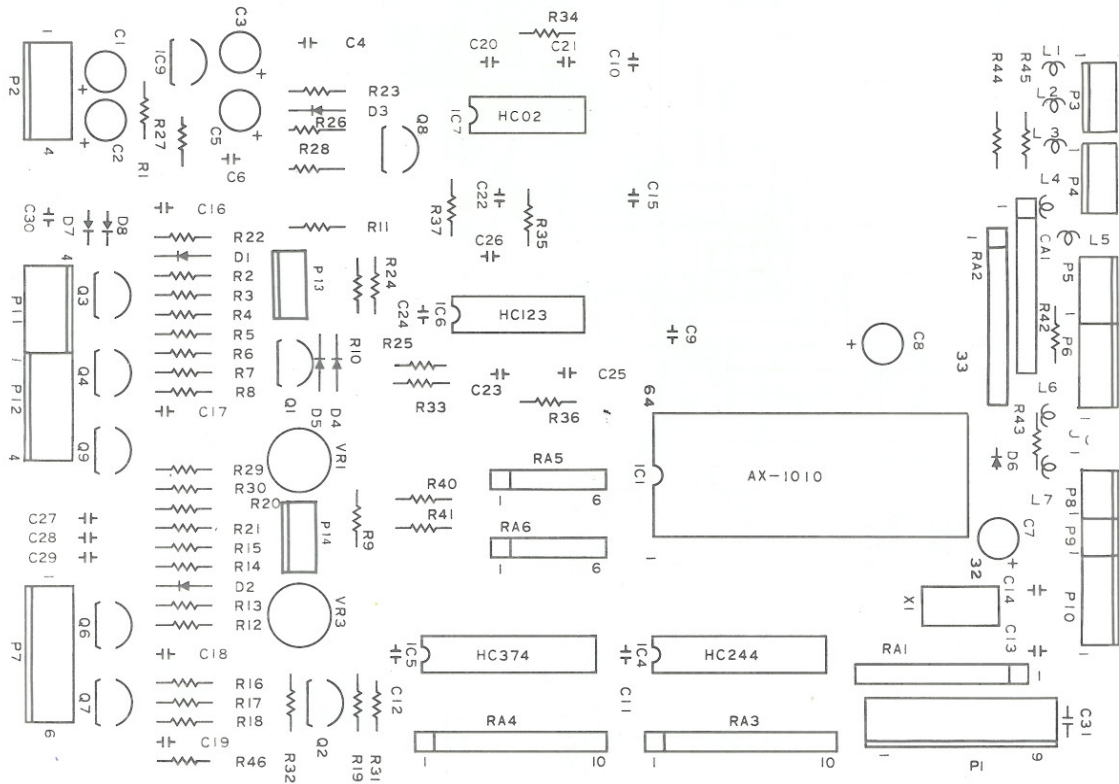

01-034-04

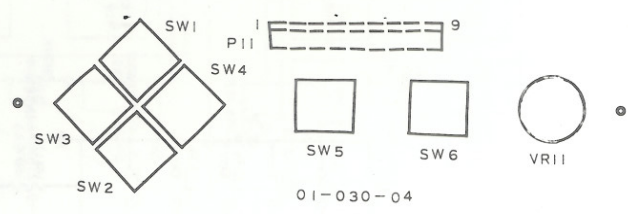
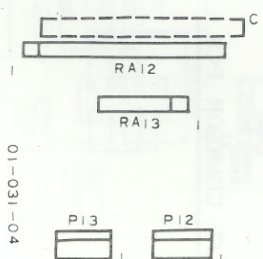
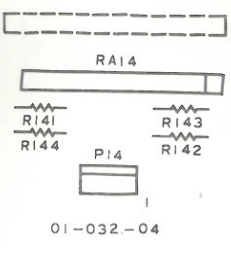
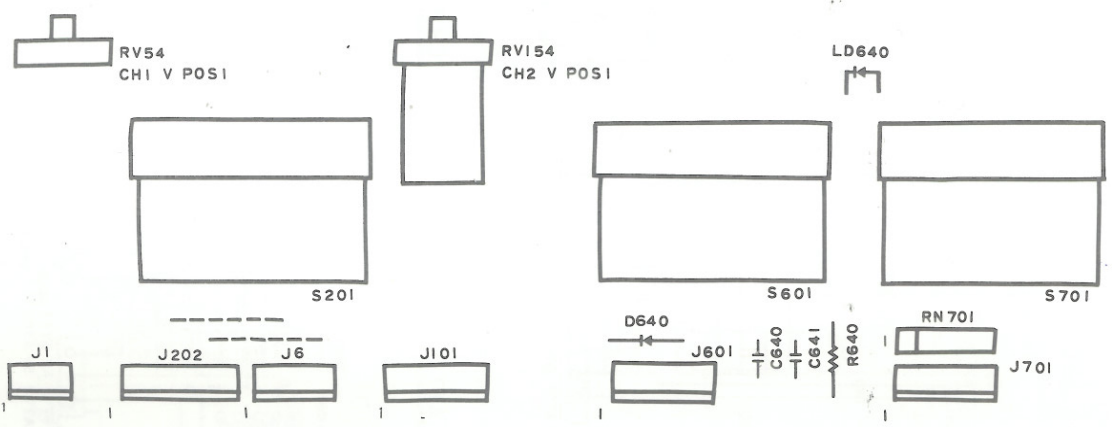

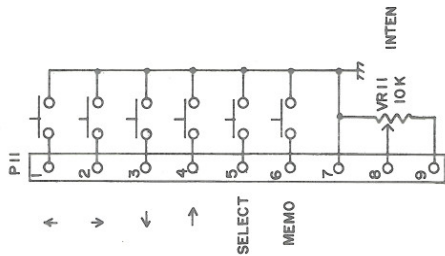

READ OUT CURSOR PCB

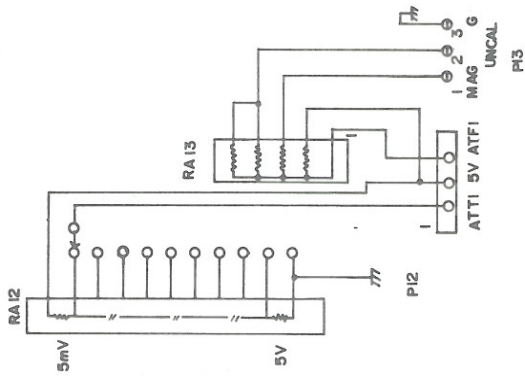

CHI ATT PCB

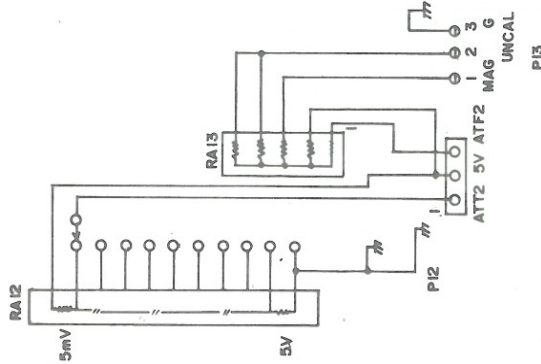

CH2 ATT PCB

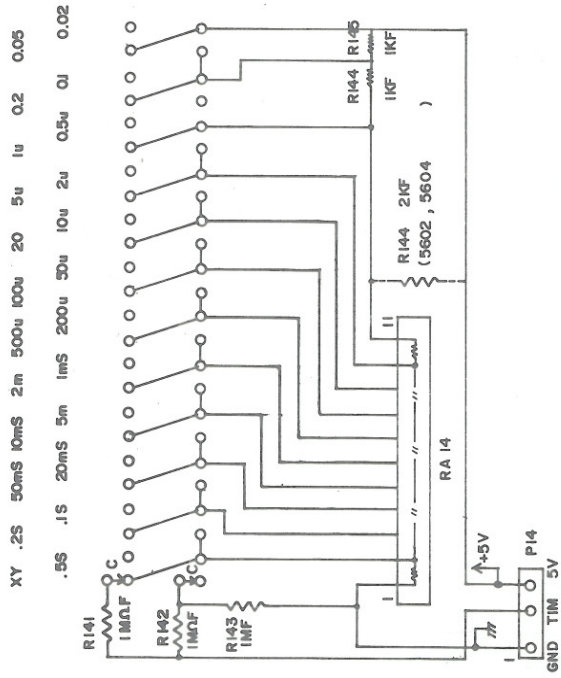

TIME BASE S/W PCB

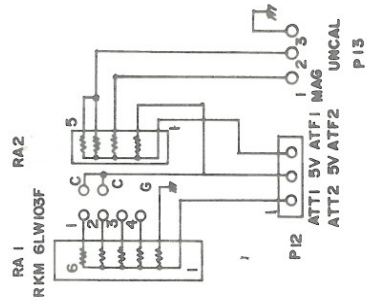

5610 ATT

* 5602
5604

READ OUT S/W UNIT
5602, 5604
99. 6. 21

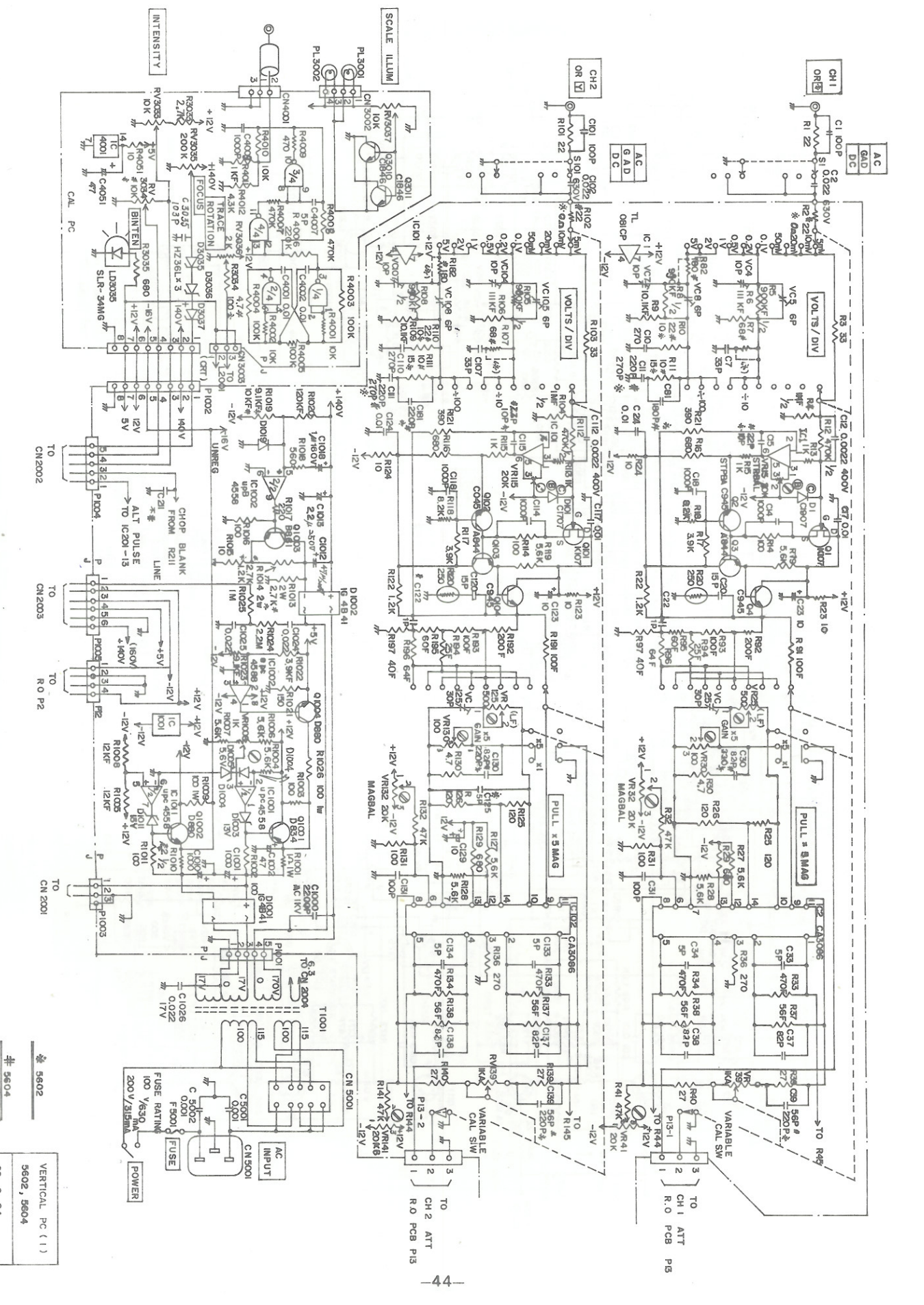

5802	VERTICAL PC (1)
5804	5802, 5804
5804	88, 6, 24

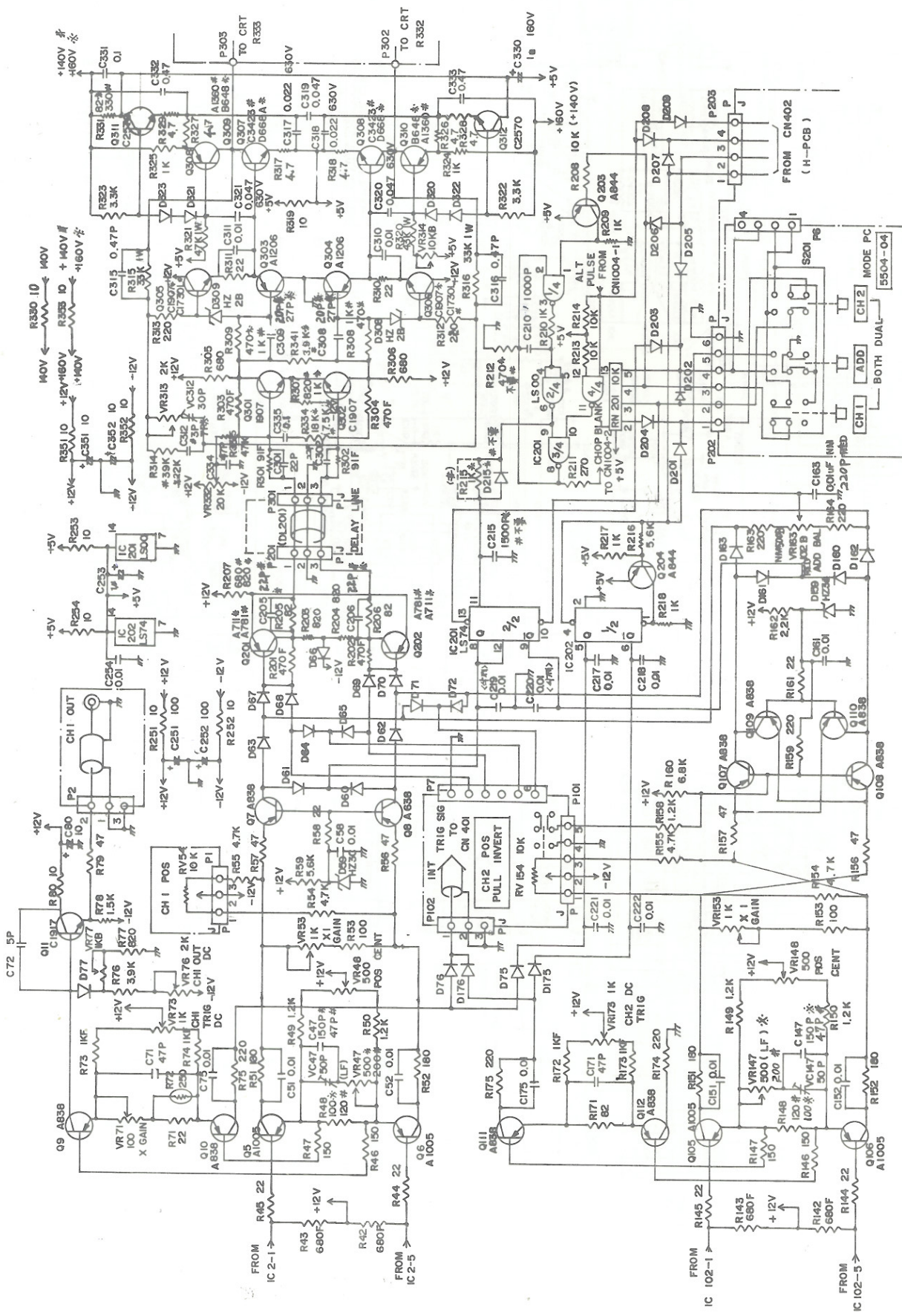

VERTICAL PC (2)
5602, 5604
1988. 6

※ 5602
5604

VERTICAL MODE

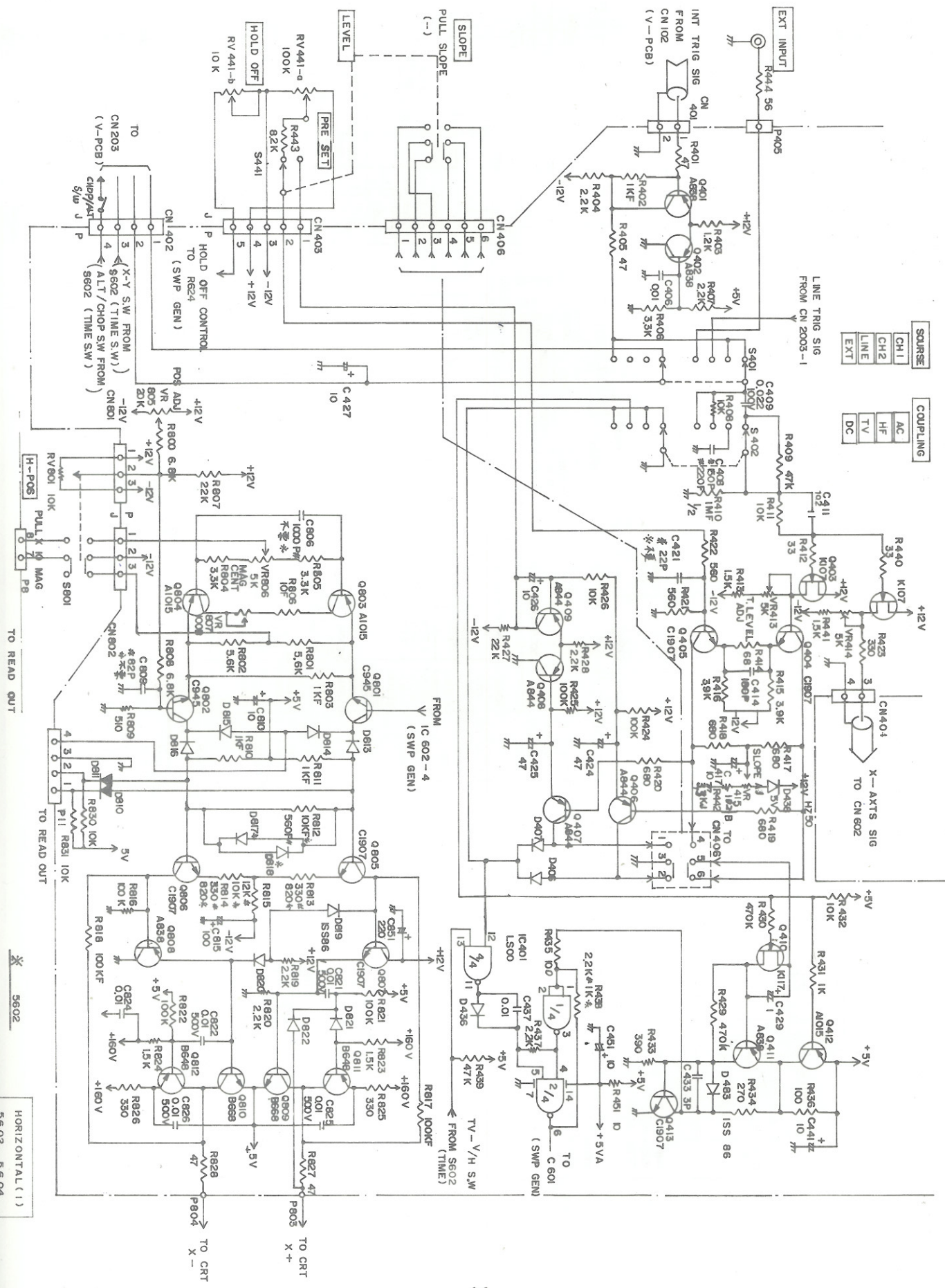

SOURCE	
CH 1	AC
CH 2	HF
LINE	TV
EXT	DC

* 5602
 † 5604
 HORIZONTAL (1)
 5602, 5604
 1988. 6.

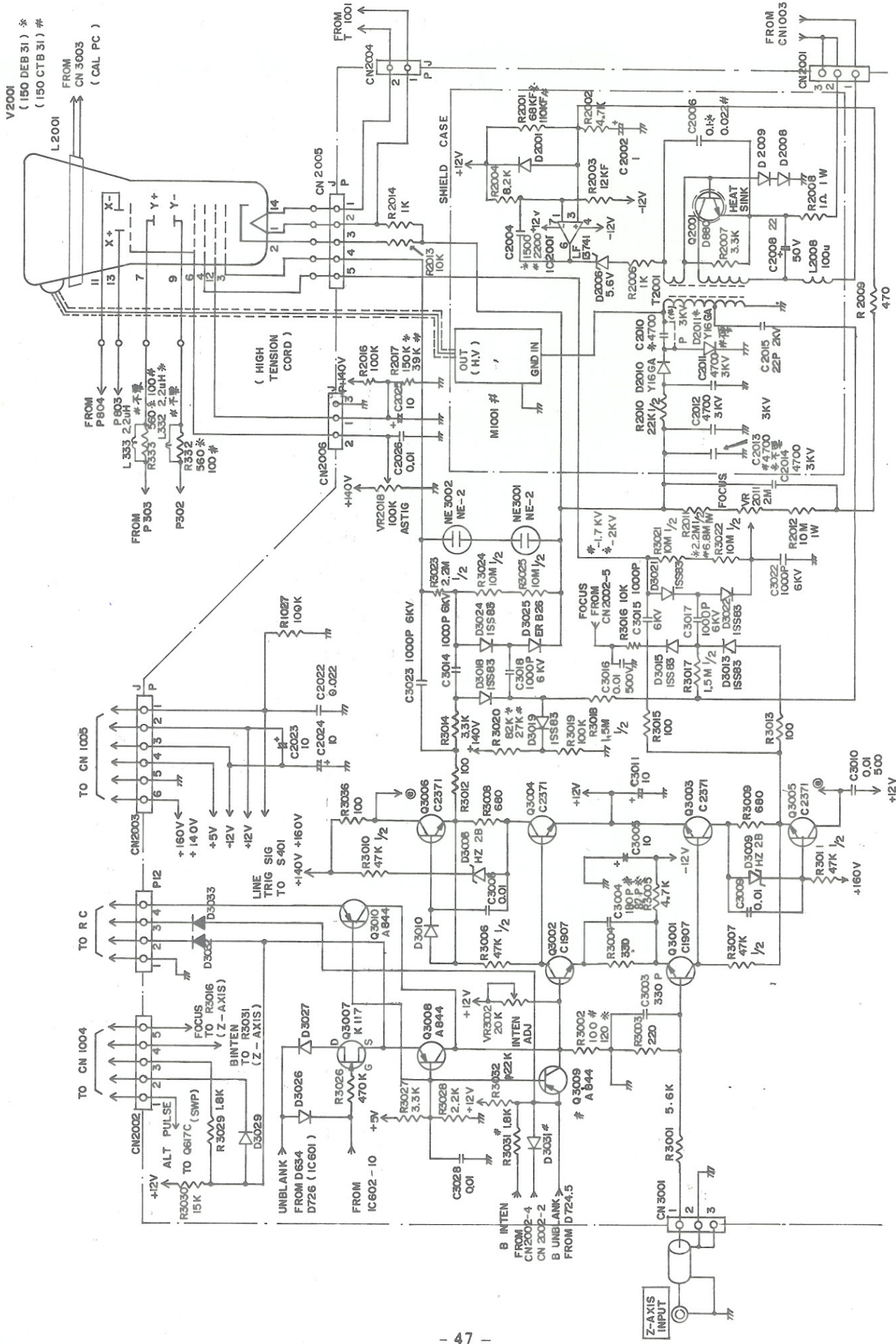

V2001
(150 DEB 31) *
(150 CTB 31) #

HORIZONTAL (2)	
5 02,	5 04
# 5604	

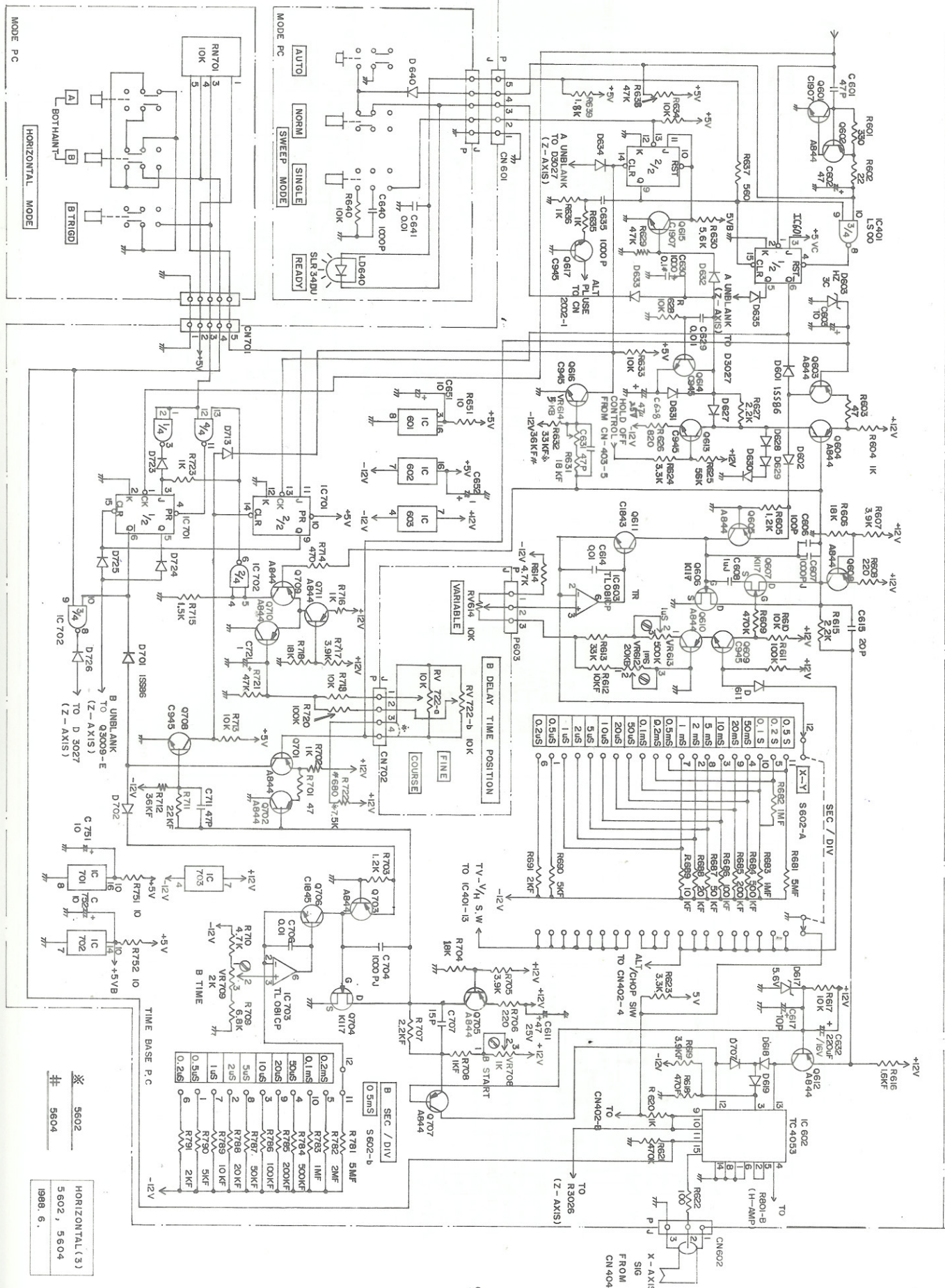

※ 5602
 # 5604
 HORIZONTAL (3)
 5602, 5604
 1988. 6.

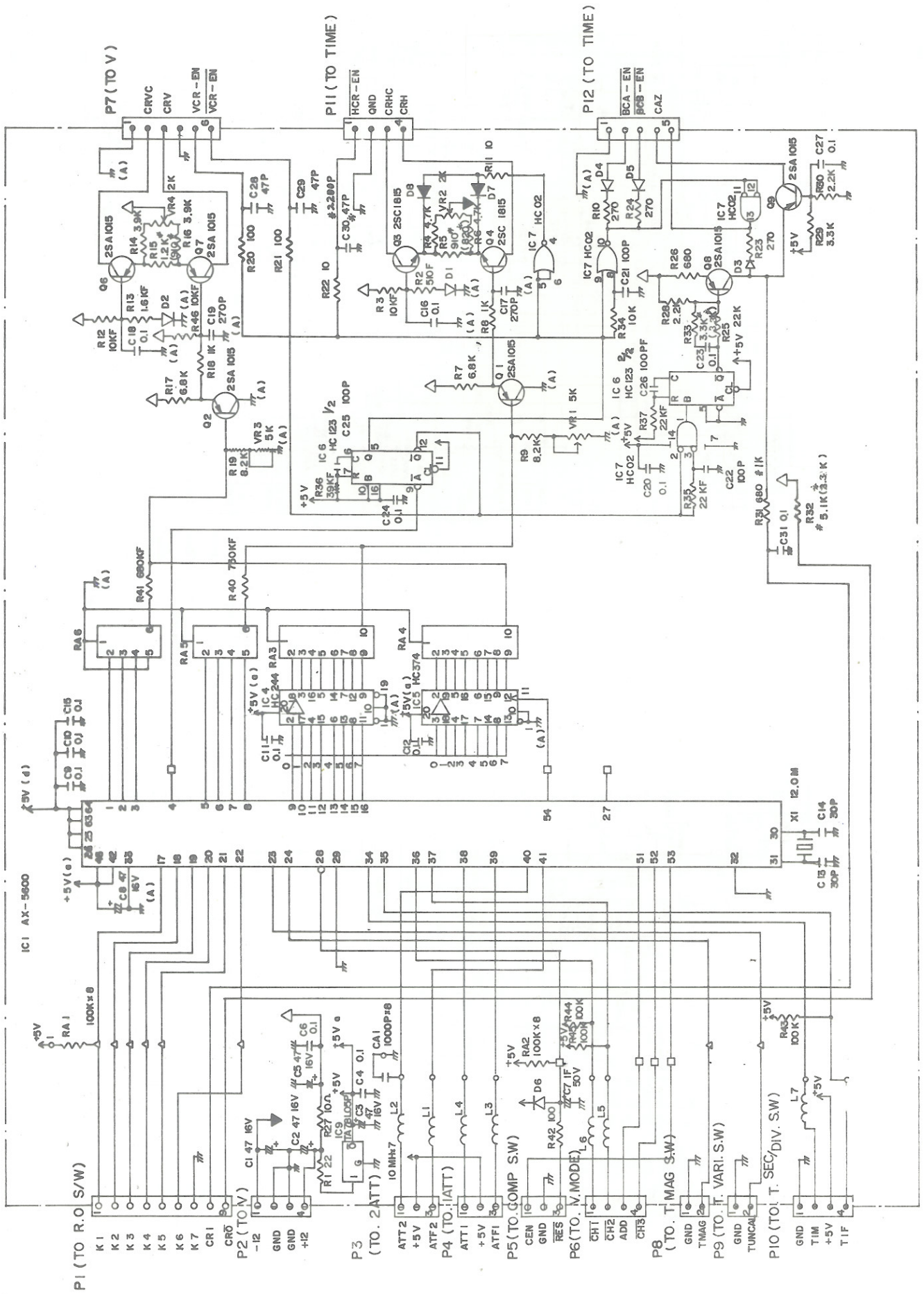

READ OUT CPU UNIT
56 02, 56 04
86. 6.

* 5602
5604



HUNG CHANG PRODUCTS CO., LTD.

C.P.O. Box 3125

Seoul, Korea

Tel : (02) 732-8611/20

Tlx : ELECHCP K28447

Fax: (02) 733-5385